

NPD12-75Ah 12V75Ah

Specifications

Nominal Voltage	12V	
Rated capacity (10 hour rate)	75Ah	
Dimensions	Length	260±2mm(10.24inch)
	Width	168±2mm(6.61inch)
	Height	211±2mm(8.31inch)
	Total Height	215±2mm(8.46inch)
Approx. Weight	24.2kg(53.3lbs)±3%	



Outer dimensions (mm)

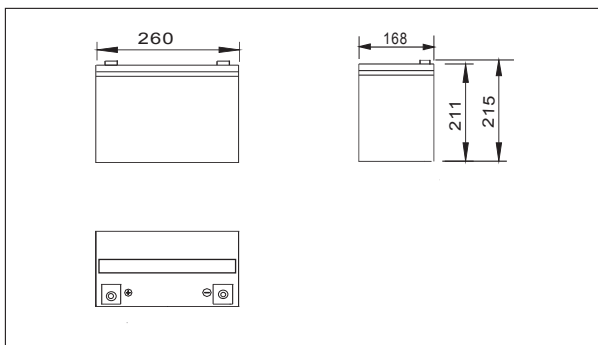

Terminal Type (mm)

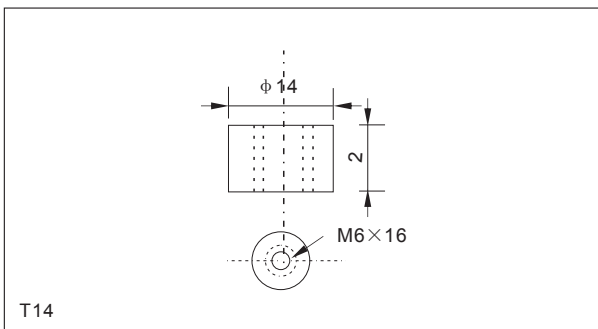

Characteristics

Capacity (25°C)	10HR(10.8V)	75Ah
	3HR(10.8V)	57Ah
	1HR(10.5V)	43Ah
Terminal type		T14
Internal resistance (Fully charged, 25°C)		Approx. 5.5m Ω
Capacity affected by temperature (10HR)	40°C	102%
	25°C	100%
	0°C	85%
	-15°C	65%
Self-discharge (25°C)	3 months	Remaining Capacity:91%
	6 months	Remaining Capacity:82%
	12 months	Remaining Capacity:65%
Nominal operating temperature		25°C ±3°C(77°F ±5°F)
Operating temperature range	Discharge	-15°C~50°C(5°F~122°F)
	Charge	-10°C~50°C(14°F~122°F)
	Storage	-20°C~50°C(-4°F~122°F)
Float charging voltage(25°C)		13.50 to 13.80V Temperature compensation: -18mV/°C
Cyclic charging voltage(25°C)		14.50 to 15.00V Temperature compensation: -30mV/°C
Maximum charging current		22.5A
Maximum discharge current		700A(5 sec.)
Designed floating life(20°C)		10years

Construction

Component	Positive plate	Negative plate	Container	Cover	Separator	Electrolyte	Safety valve	Terminal
Raw material	Lead dioxide	Lead	ABS	ABS	AGM	Sulfuric acid	Rubber	Copper

Constant Current Discharge Characteristics Unit:A(25°C,77°F)

F.V/Time	10min	15min	30min	60min	2h	3h	4h	5h	8h	10h	20h
9.60V	170	131	78.4	48.2	28.5	20.5	16.4	14.0	9.63	7.94	4.21
9.90V	165	128	76.8	47.5	28.3	20.4	16.3	13.9	9.57	7.92	4.20
10.2V	158	123	74.5	46.3	28.1	20.3	16.2	13.8	9.50	7.90	4.19
10.5V	151	119	72.7	44.8	27.7	20.1	16.1	13.7	9.44	7.85	4.16
10.8V	143	113	70.0	43.4	27.0	19.5	15.6	13.3	9.15	7.80	4.13

Constant Power Discharge Characteristics Unit:W(25°C,77°F)

F.V/Time	10min	15min	30min	60min	2h	3h	4h	5h	8h	10h	20h
9.60V	1836	1439	880	550	330	241	193	166	114	94.8	50.5
9.90V	1781	1404	862	541	328	240	192	165	114	94.6	50.4
10.2V	1708	1352	836	528	325	238	190	163	113	84.3	50.3
10.5V	1634	1306	815	511	320	237	189	162	112	93.8	50.0
10.8V	1543	1237	785	495	312	230	183	157	109	93.1	49.6

Note: The above characteristics data can be obtained within three charge or discharge cycles.

NPD12-75Ah 12V75Ah

● Discharge characteristics(25°C)

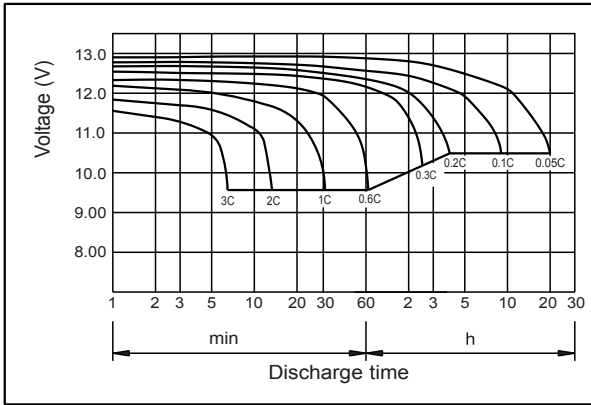

● Charging characteristics (25°C)

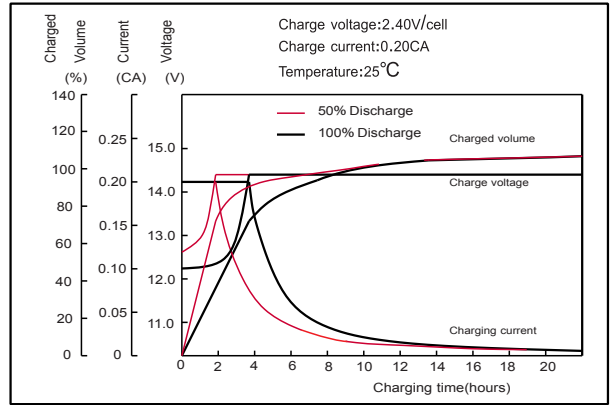

● Temperature effects on Capacity

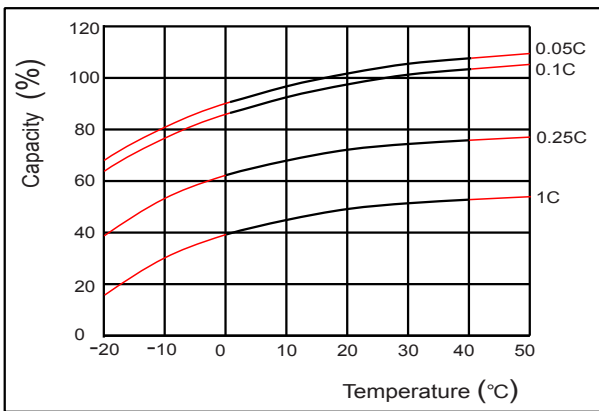

● Self-discharge characteristics

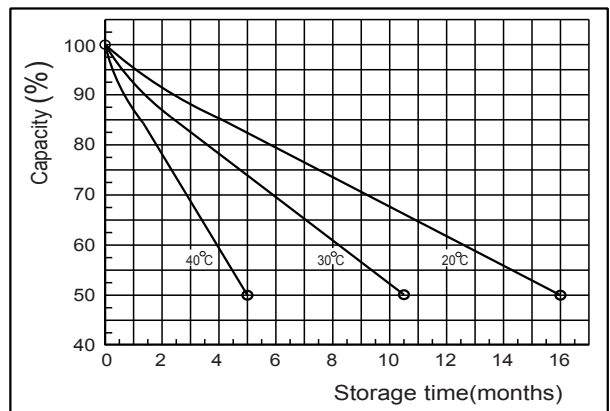

● Floating life on Temperature

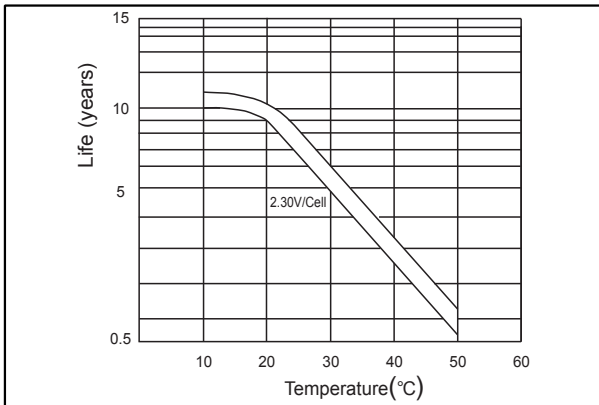

● Cycle life on D.O.D (25°C)

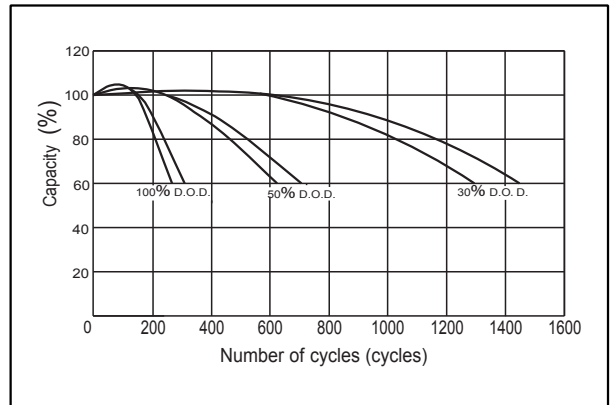

● The relationship for OCV and Capacity (25°C)

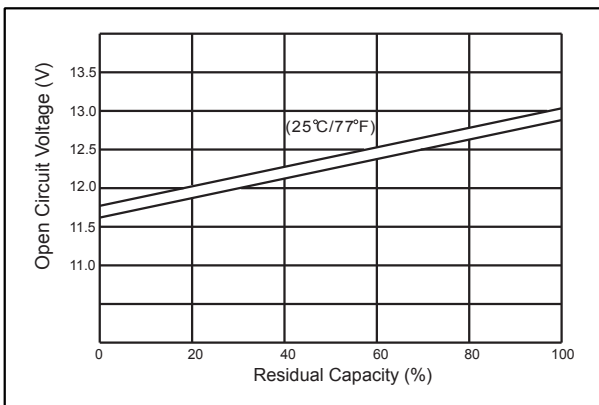

● The relationship for Charging voltage and Temperature

