

NPD12-70Ah 12V70Ah

Specifications

Nominal Voltage		12V
Rated capacity (10 hour rate)		70Ah
Dimensions	Length	260±2mm(10.24inch)
	Width	168±2mm(6.61inch)
	Height	211±2mm(8.31inch)
	Total Height	215±2mm(8.46inch)
Approx. Weight		23.2kg(51.1lbs)±3%



Outer dimensions (mm)

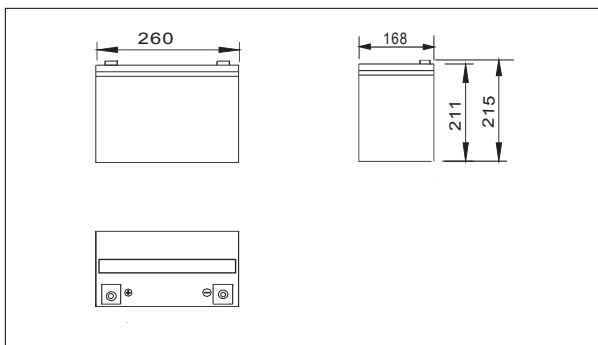

Terminal Type (mm)

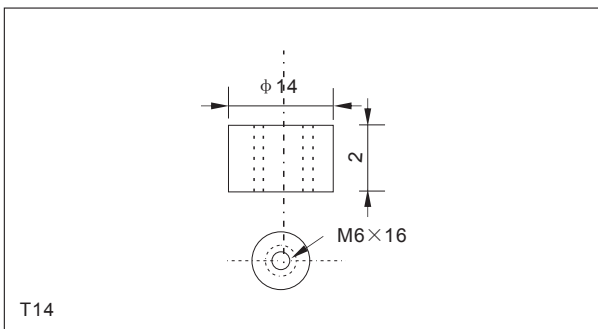

Characteristics

Capacity (25°C)	10HR(10.8V)	70Ah
	3HR(10.8V)	54Ah
	1HR(10.5V)	41Ah
Terminal type		T14
Internal resistance (Fully charged, 25°C)		Approx. 5.5m Ω
Capacity affected by temperature (10HR)	40°C	102%
	25°C	100%
	0°C	85%
	-15°C	65%
Self-discharge (25°C)	3 months	Remaining Capacity:91%
	6 months	Remaining Capacity:82%
	12 months	Remaining Capacity:65%
Nominal operating temperature		25°C ±3°C(77°F ±5°F)
Operating temperature range	Discharge	-15°C~50°C(5°F~122°F)
	Charge	-10°C~50°C(14°F~122°F)
	Storage	-20°C~50°C(-4°F~122°F)
Float charging voltage(25°C)		13.50 to 13.80V Temperature compensation: -18mV/°C
Cyclic charging voltage(25°C)		14.50 to 15.00V Temperature compensation: -30mV/°C
Maximum charging current		21A
Maximum discharge current		700A(5 sec.)
Designed floating life(20°C)		10years

Construction

Component	Positive plate	Negative plate	Container	Cover	Separator	Electrolyte	Safety valve	Terminal
Raw material	Lead dioxide	Lead	ABS	ABS	AGM	Sulfuric acid	Rubber	Copper

Constant Current Discharge Characteristics Unit:A(25°C,77°F)

F.V/Time	10min	15min	30min	60min	2h	3h	4h	5h	8h	10h	20h
9.60V	161	124	74.4	45.7	27.0	19.5	15.5	13.3	9.13	7.53	3.99
9.90V	156	121	72.9	45.0	26.9	19.4	15.5	13.2	9.08	7.52	3.98
10.2V	150	117	70.7	43.9	26.6	19.2	15.4	13.1	9.02	7.50	3.97
10.5V	144	113	68.9	42.5	26.2	19.1	15.2	13.0	8.95	7.45	3.95
10.8V	136	107	66.4	41.2	25.6	18.5	14.8	12.6	8.69	7.40	3.92

Constant Power Discharge Characteristics Unit:W(25°C,77°F)

F.V/Time	10min	15min	30min	60min	2h	3h	4h	5h	8h	10h	20h
9.60V	1742	1365	834	521	313	229	183	157	109	89.9	47.9
9.90V	1690	1332	818	514	311	228	182	156	108	89.8	47.8
10.2V	1620	1283	793	500	308	226	181	155	107	89.5	47.7
10.5V	1551	1239	774	485	304	225	179	154	106	89.0	47.4
10.8V	1463	1174	745	469	296	218	174	149	103	88.4	47.1

Note: The above characteristics data can be obtained within three charge or discharge cycles.

NPD12-70Ah 12V70Ah

● Discharge characteristics(25°C)

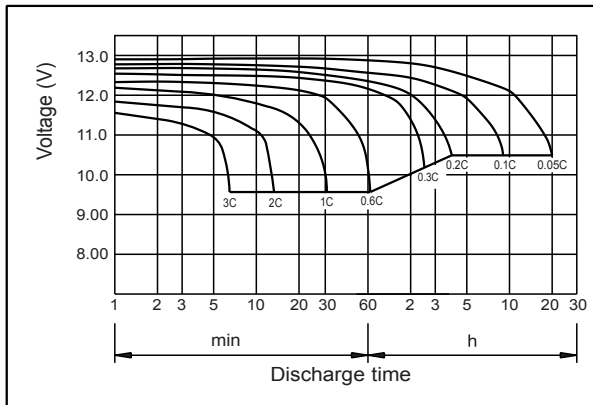

● Charging characteristics (25°C)

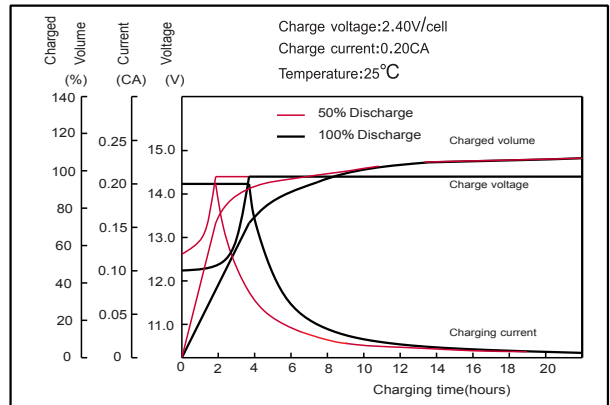

● Temperature effects on Capacity

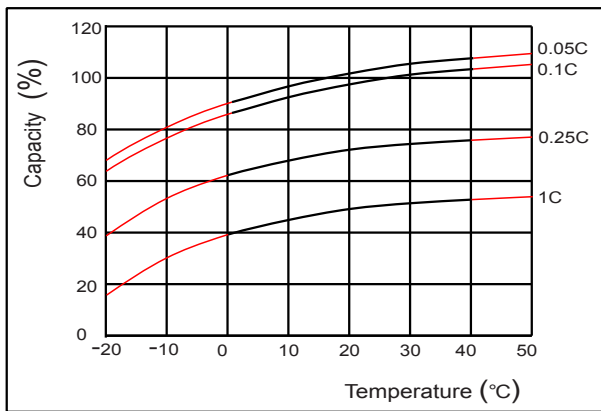

● Self-discharge characteristics

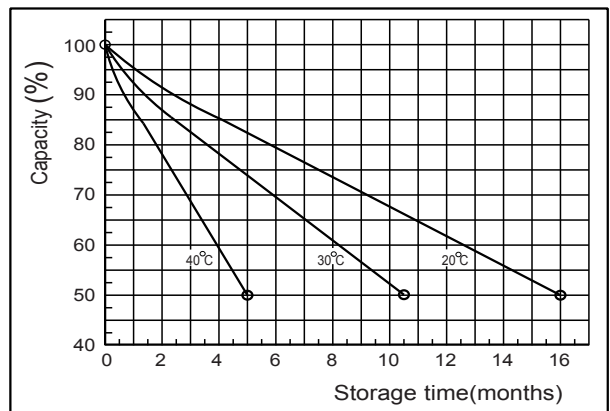

● Floating life on Temperature

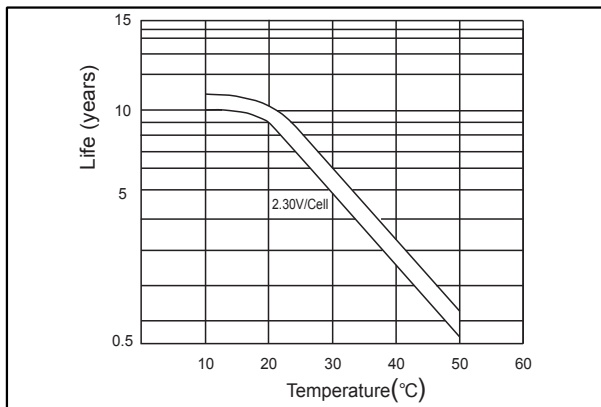

● Cycle life on D.O.D (25°C)

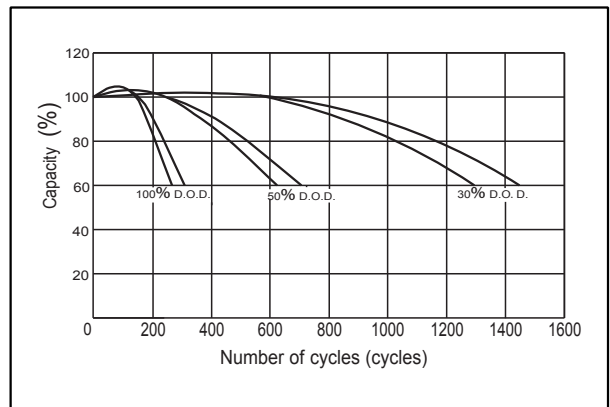

● The relationship for OCV and Capacity (25°C)

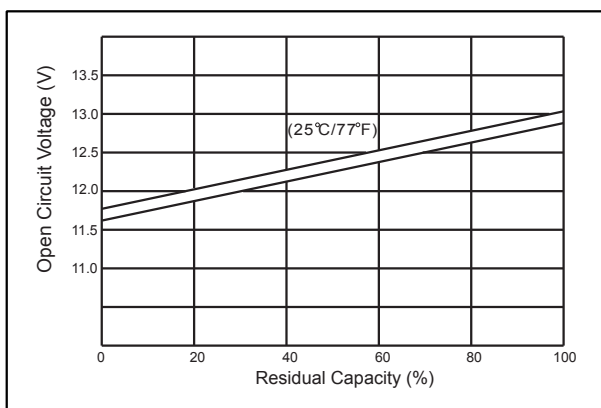

● The relationship for Charging voltage and Temperature

