

NP12-2.9Ah 12V2.9Ah

● **Specifications**

| | | |
|-------------------------------|--------------|--------------------|
| Nominal Voltage | | 12V |
| Rated capacity (20 hour rate) | | 2.9Ah |
| Dimensions | Length | 79±2mm(3.11inch) |
| | Width | 56±1mm(2.20inch) |
| | Height | 99±1mm(3.90inch) |
| | Total Height | 104±1mm(4.09inch) |
| Approx. Weight | | 1.05kg(2.31lbs)±5% |



● **Outer dimensions (mm)**

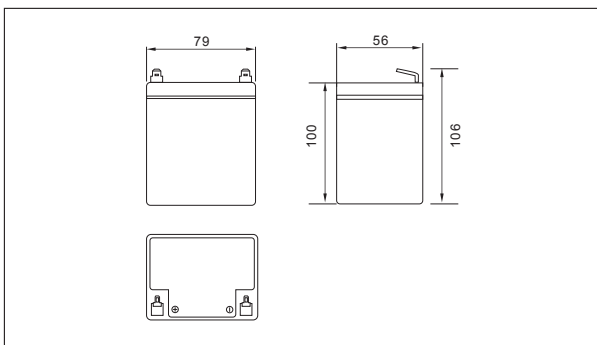

● **Terminal Type (mm)**

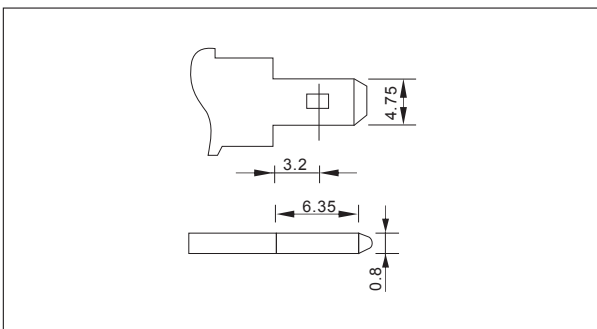

● **Characteristics**

| | | |
|--|-------------|---|
| Capacity (25°C) | 20HR(10.5V) | 2.9Ah |
| | 10HR(10.5V) | 2.7Ah |
| | 1HR(9.60V) | 1.8Ah |
| Terminal type | | T1 |
| Internal resistance (Fully charged,25°C) | | Approx.45m Ω |
| Capacity affected by temperature (20HR) | 40°C | 102% |
| | 25°C | 100% |
| | 0°C | 85% |
| | -15°C | 65% |
| Self-discharge (25°C) | 3month | Remaining Capacity:91% |
| | 6month | Remaining Capacity:82% |
| | 12month | Remaining Capacity:65% |
| Nominal operating temperature | | 25°C ±3°C(77°F ±5°F) |
| Operating temperature range | Discharge | -15°C~50°C(5°F~122°F) |
| | Charge | -10°C~50°C(14°F~122°F) |
| | Storage | -20°C~50°C(-4°F~122°F) |
| Float charging voltage(25°C) | | 13.50 to 13.80V Temperature compensation: -18mV/°C |
| Cyclic charging voltage(25°C) | | 14.50 to 15.00V Temperature compensation: -30mV/°C |
| Maximum charging current | | 0.87A |
| Maximum discharge current | | 43.5A(5 sec.) |
| Designed floating life(20°C) | | 5 years |

● **Construction**

| Component | Positive plate | Negative plate | Container | Cover | Separator | Electrolyte | Safety valve | Terminal |
|--------------|----------------|----------------|-----------|-------|-----------|---------------|--------------|----------|
| Raw material | Lead dioxide | Lead | ABS | ABS | AGM | Sulfuric acid | Rubber | Copper |

● **Constant Current Discharge Characteristics Unit:A(25°C,77°F)**

| F.V/Time | 5min | 10min | 15min | 30min | 60min | 2h | 3h | 4h | 5h | 10h | 20h |
|----------|------|-------|-------|-------|-------|------|------|------|------|------|------|
| 9.60V | 11.1 | 7.02 | 5.48 | 3.09 | 1.90 | 1.04 | 0.72 | 0.59 | 0.51 | 0.27 | 0.15 |
| 9.90V | 10.7 | 6.81 | 5.35 | 3.03 | 1.87 | 1.03 | 0.71 | 0.59 | 0.50 | 0.27 | 0.15 |
| 10.2V | 10.3 | 6.53 | 5.15 | 2.93 | 1.82 | 1.02 | 0.71 | 0.59 | 0.50 | 0.27 | 0.15 |
| 10.5V | 9.86 | 6.25 | 4.98 | 2.86 | 1.79 | 1.10 | 0.70 | 0.58 | 0.50 | 0.27 | 0.15 |
| 10.8V | 9.31 | 5.90 | 4.71 | 2.76 | 1.73 | 0.98 | 0.68 | 0.57 | 0.48 | 0.27 | 0.14 |

● **Constant Power Discharge Characteristics Unit:W(25°C,77°F)**

| F.V/Time | 5min | 10min | 15min | 30min | 60min | 2h | 3h | 4h | 5h | 10h | 20h |
|----------|------|-------|-------|-------|-------|------|------|------|------|------|------|
| 9.60V | 124 | 79.2 | 62.5 | 35.4 | 22.0 | 12.2 | 8.54 | 7.08 | 6.04 | 3.30 | 1.77 |
| 9.90V | 120 | 76.8 | 61.0 | 34.7 | 21.7 | 12.1 | 8.49 | 7.04 | 6.00 | 3.28 | 1.76 |
| 10.2V | 115 | 73.6 | 58.7 | 33.6 | 21.1 | 12.0 | 8.43 | 6.99 | 5.96 | 3.27 | 1.75 |
| 10.5V | 110 | 70.5 | 56.7 | 32.8 | 20.7 | 11.8 | 8.37 | 6.94 | 5.92 | 3.25 | 1.74 |
| 10.8V | 104 | 66.5 | 53.7 | 31.6 | 20.1 | 11.5 | 8.12 | 6.73 | 5.74 | 3.18 | 1.71 |

Note: The above characteristics data can be obtained within three charge or discharge cycles.

NP12-2.9Ah 12V2.9Ah

● Discharge characteristics(25°C)

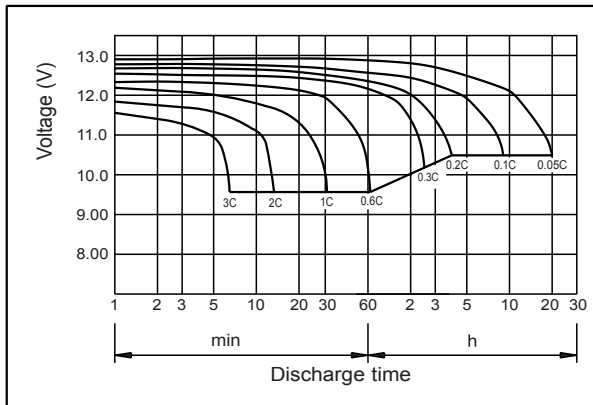

● Charging characteristics (25°C)

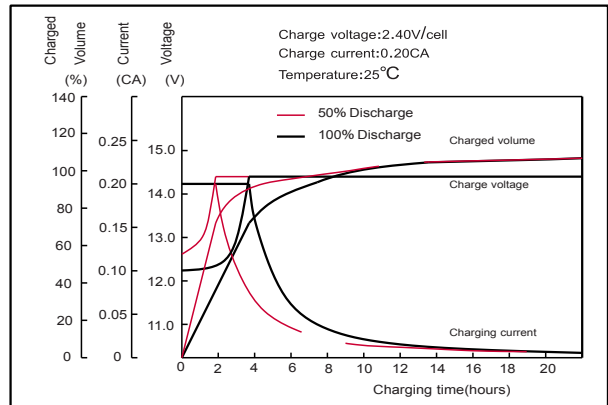

● Effect of temperature on capacity

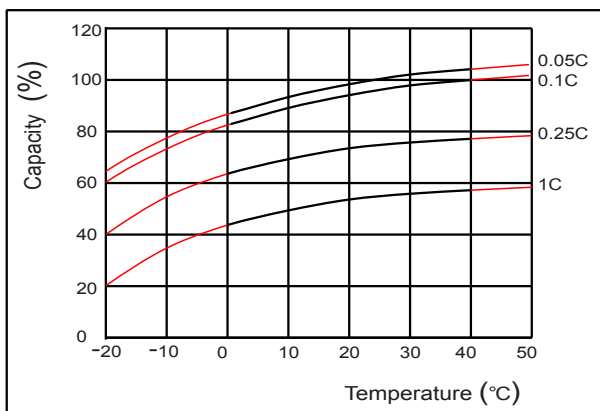

● Self-discharge characteristics

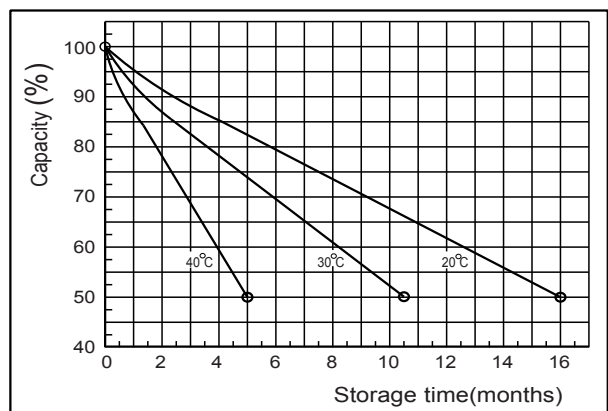

● Floating life on temperature

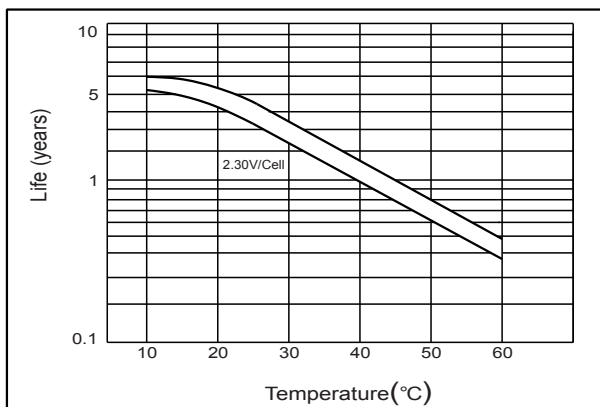

● Cycle life on D.O.D.(25°C)

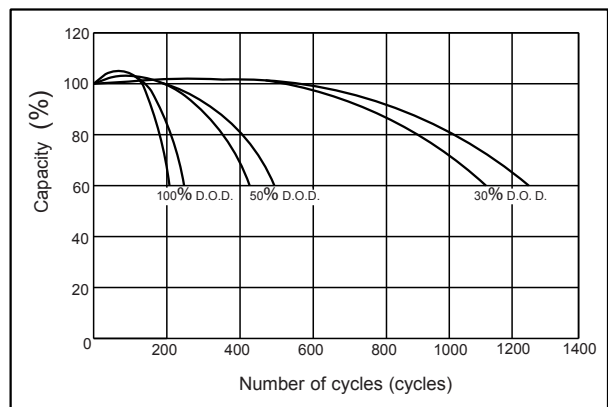

● The relationship for OCV and Capacity (25°C)

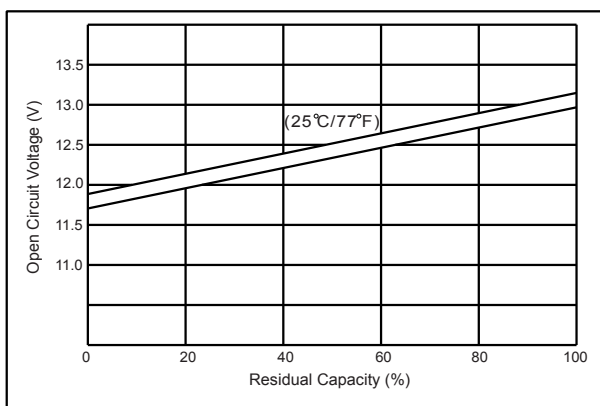

● The relationship for Charging voltage and Temperature

