

FT12-155Ah 12V155Ah

Specifications

Nominal Voltage	12V	
Rated capacity (10 hour rate)	155Ah	
Dimensions	Length	546±3mm(21.50inch)
	Width	125±1mm(4.92inch)
	Height	315±2mm(12.40inch)
	Total Height	315±2mm(12.40inch)
Approx. Weight	49.5kg(109.1lbs)±3%	

Outer dimensions (mm)

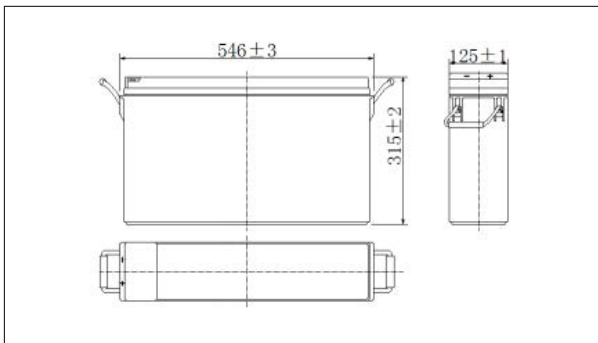

Terminal Type (mm)

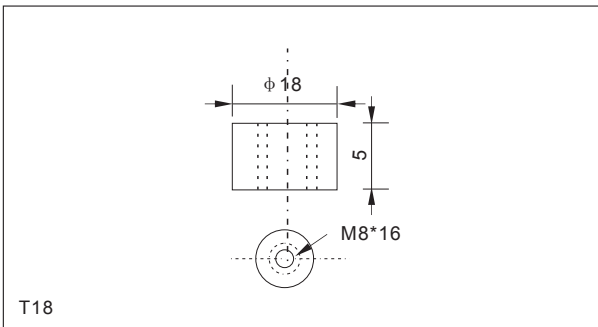

Characteristics

Capacity (25°C)	10HR(10.8V)	155Ah
	3HR(10.8V)	117Ah
	1HR(10.5V)	86Ah
Terminal type		T18
Internal resistance (Fully charged,25°C)		Approx.4m Ω
Capacity affected by temperature (10HR)	40°C	102%
	25°C	100%
	0°C	85%
	-15°C	65%
Self-discharge (25°C)	3 months	Remaining Capacity:91%
	6 months	Remaining Capacity:82%
	12 months	Remaining Capacity:65%
Nominal operating temperature		25°C ±3°C(77°F ±5°F)
Operating temperature range	Discharge	-15°C~50°C(5°F~122°F)
	Charge	-10°C~50°C(14°F~122°F)
	Storage	-20°C~50°C(-4°F~122°F)
Float charging voltage(25°C)		13.50 to 13.80V Temperature compensation: -18mV/°C
Cyclic charging voltage(25°C)		14.50 to 15.00V Temperature compensation: -30mV/°C
Maximum charging current		46.5A
Maximum discharge current		1100A(5 sec.)
Designed floating life(20°C)		12years

Construction

Component	Positive plate	Negative plate	Container	Cover	Separator	Electrolyte	Safety valve	Terminal
Raw material	lead dioxide	Lead	ABS	ABS	AGM	Sulfuric acid	Rubber	Copper

Constant Current Discharge Characteristics Unit:A(25°C,77°F)

F.V/Time	15min	30min	60min	2h	3h	4h	5h	6h	8h	10h	20h
9.60V	255	153	93.9	56.6	40.8	32.6	27.8	24.2	19.1	15.8	8.36
9.90V	249	150	92.5	56.3	40.5	32.4	27.7	24.0	19.0	15.7	8.35
10.2V	240	145	90.1	55.8	40.3	32.2	27.5	23.9	18.9	15.7	8.32
10.5V	232	142	87.3	55.0	40.0	31.9	27.3	23.7	18.8	15.6	8.27
10.8V	219	136	84.5	53.6	38.8	31.0	26.5	23.0	18.2	15.5	8.22

Constant Power Discharge Characteristics Unit:W(25°C,77°F)

F.V/Time	15min	30min	60min	2h	3h	4h	5h	6h	8h	10h	20h
9.60V	2802	1713	1070	656	480	383	329	286	227	188	100
9.90V	2735	1679	1054	652	477	381	327	284	226	188	100
10.2V	2634	1627	1027	646	474	378	325	282	224	187	99.9
10.5V	2544	1588	995	636	470	375	322	280	223	186	99.3
10.8V	2410	1530	963	620	456	364	313	272	216	185	98.6

Note: The above characteristics data can be obtained within three charge or discharge cycles.

FT12-150Ah 12V150Ah

Discharge characteristics(25°C)

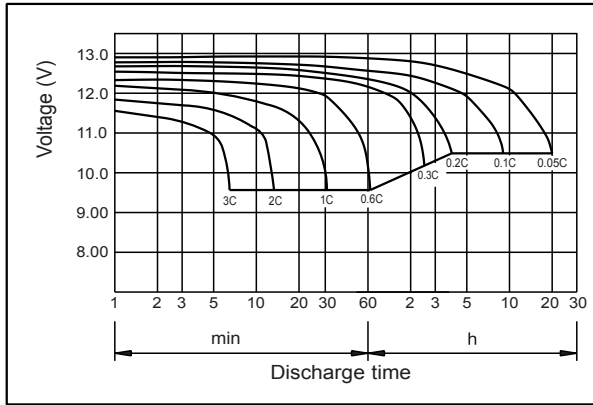

Charging characteristics

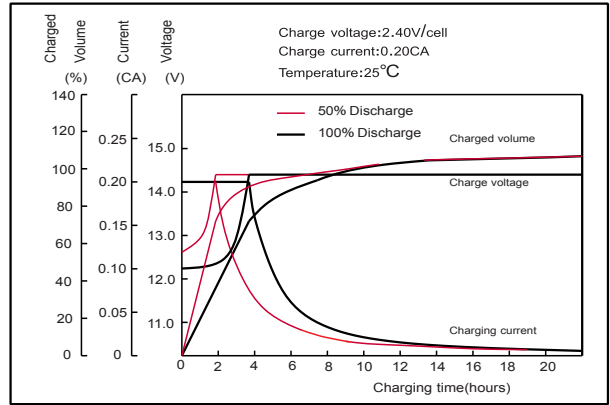

Temperature effects on Capacity



Self-discharge characteristics



Temperature effects on float life

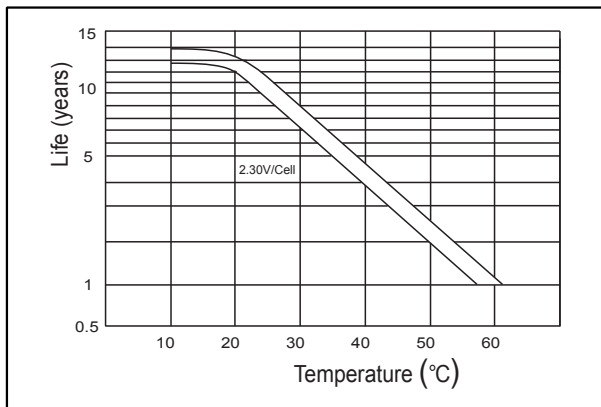

Cycle service life in relation to depth of discharge

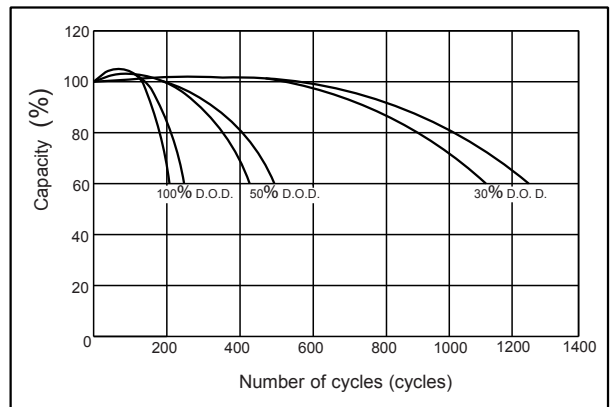

The relationship for OCV and Capacity (25°C)

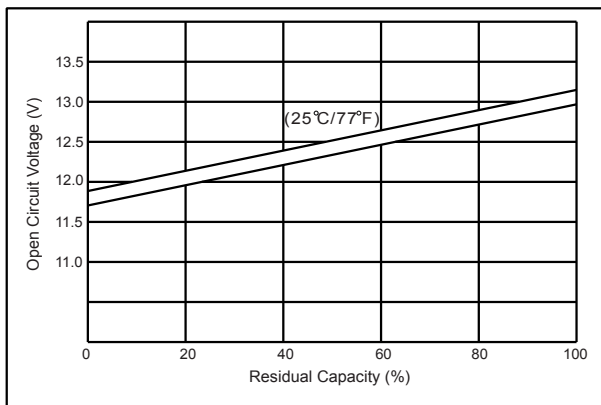

The relationship for Charging voltage and Temperature

