

HR1276W-FR (12V76 Watts/cell)

Specifications

Nominal Voltage	12V	
Number of cell	6 cells	
Rated capacity(15min.rat)	76 Watts/cell	
Dimensions	Length	181±2mm(7.13inch)
	Width	77±1mm(3.03inch)
	Height	167±2mm(6.57inch)
	Total Height	167±2mm(6.57inch)
Approx. Weight	5.7kg(12.6lbs)±3%	

Outer dimensions (mm)

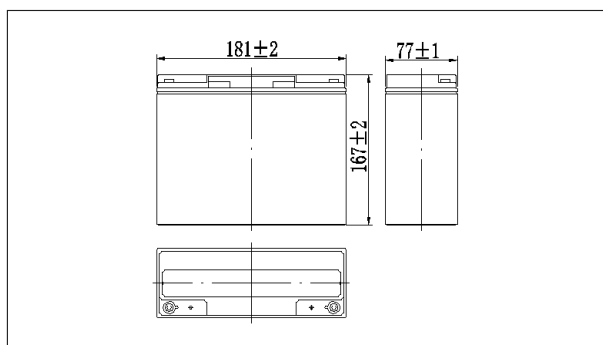

Terminal Type (mm)

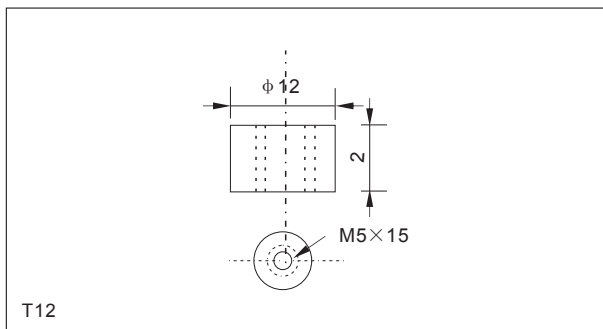

Characteristics

Capacity(20HR,25°C)	18Ah	
Capacity(15min.rate,25°C)	76 Watts/cell	
Terminal type	T12	
Internal resistance (Fully charged,25°C)	Approx. 12m Ω	
Capacity affected by temperature (10HR)	40°C	102%
	25°C	100%
	0°C	85%
	-15°C	65%
Self-discharge (25°C)	3 months	Remaining Capacity:91%
	6 months	Remaining Capacity:82%
	12 months	Remaining Capacity:65%
Nominal operating temperature	25°C ±3°C(77°F ±5°F)	
Operating temperature range	Discharge	-15°C~50°C(5°F~122°F)
	Charge	-10°C~50°C(14°F~122°F)
	Storage	-20°C~50°C(-4°F~122°F)
Float charging voltage(25°C)	13.50 to 13.80V Temperature compensation: -18mV/°C	
Cyclic charging voltage(25°C)	14.50 to 15.00V Temperature compensation: -30mV/°C	
Maximum charging current	5.4A	
Maximum discharge current	270A(5 sec.)	
Designed floating life(20°C)	5years	

Construction

Component	Positive plate	Negative plate	Container	Cover	Separator	Electrolyte	Safety valve	Terminal
Raw material	Leaddioxide	Lead	ABS	ABS	AGM	Sulfuric acid	Rubber	Copper

Constant Current Discharge Characteristics Unit:A(25°C,77°F)

F.V/Time	5min	10min	15min	20min	30min	45min	60min	2h	3h	4h	5h
1.60V/cell	82.6	50.9	40.0	31.6	21.4	15.9	13.0	7.35	5.22	4.20	3.61
1.67V/cell	78.9	48.6	38.6	30.4	20.7	15.4	12.7	7.28	5.18	4.17	3.58
1.70V/cell	76.8	47.3	37.6	29.7	20.4	15.1	12.5	7.24	5.16	4.15	3.56
1.75V/cell	73.5	45.3	36.3	28.7	19.9	14.7	12.2	7.13	5.12	4.12	3.54
1.80V/cell	69.4	42.7	34.4	27.2	19.1	14.2	11.8	6.95	4.97	4.00	3.43

Constant Power Discharge Characteristics Unit:W(25°C,77°F)

F.V/Time	5min	10min	15min	20min	30min	45min	60min	2h	3h	4h	5h
1.60V/cell	159	98.7	79.1	62.6	42.4	31.4	25.7	14.6	10.5	8.45	7.26
1.67V/cell	151	94.3	76.4	60.1	41.1	30.4	25.1	14.5	10.4	8.37	7.19
1.70V/cell	148	91.8	74.4	58.9	40.3	29.8	24.7	14.4	10.4	8.34	7.17
1.75V/cell	141	87.9	71.8	56.8	39.3	29.1	24.2	14.2	10.3	8.28	7.12
1.80V/cell	133	82.9	68.1	53.8	37.9	28.0	23.4	13.8	9.98	8.03	6.90

Note: The above characteristics data can be obtained within three charge or discharge cycles.

HR1276W-FR (12V76 Watts/cell)

Discharge characteristics(25°C)

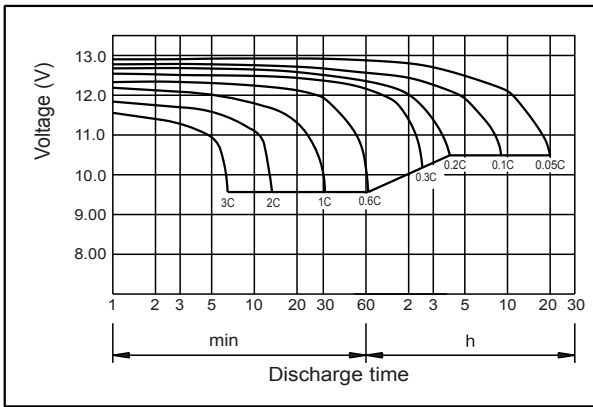

Charging characteristics (25°C)

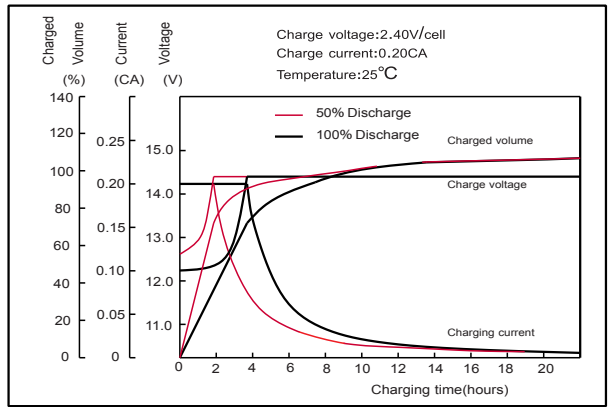

Effect of Temperature on Capacity

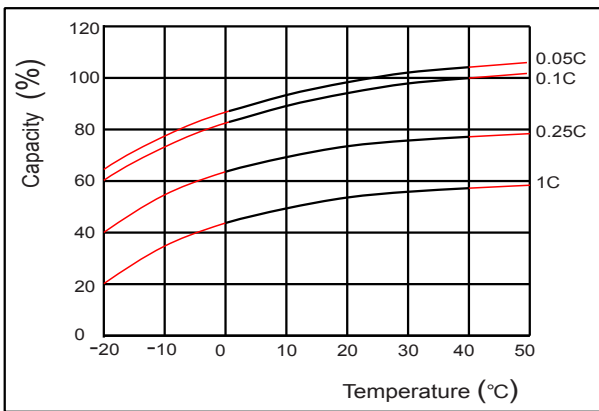

Self-discharge characteristics

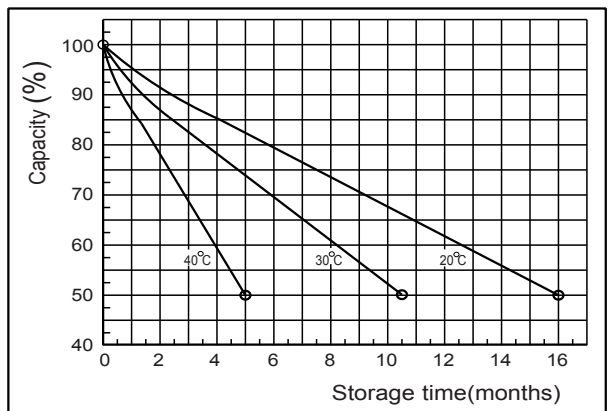

Floating Life on Temperature

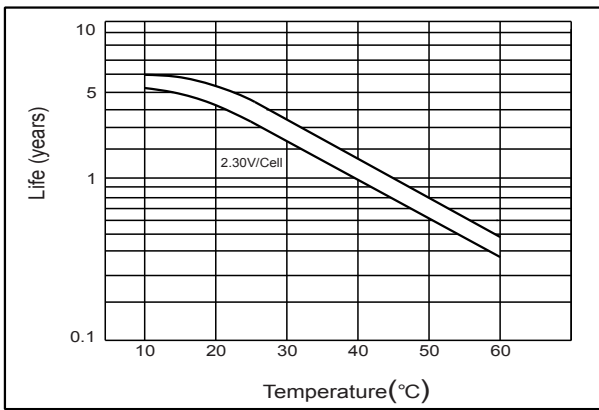

Cycle service Life on D.O.D (25°C)

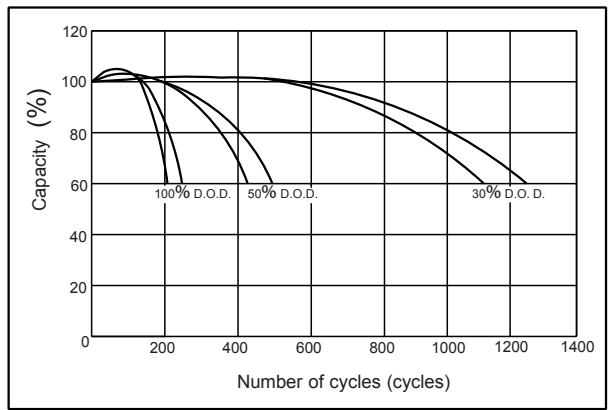

The relationship for OCV and Capacity (25°C)

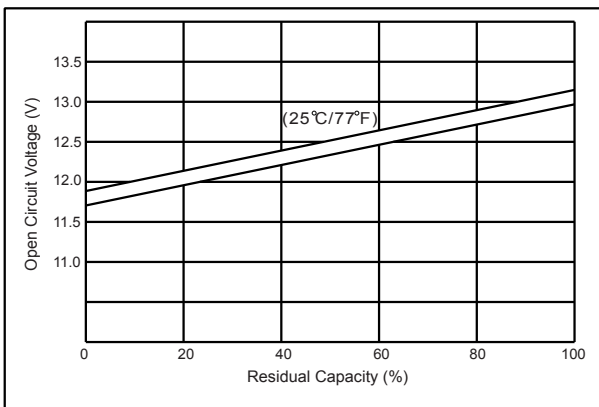

The relationship for Charging voltage and Temperature

