

NPD12-90Ah 12V90Ah

Specifications

Nominal Voltage		12V
Rated capacity (10 hour rate)		90Ah
Dimensions	Length	306±2mm(12.05inch)
	Width	169±2mm(6.65inch)
	Height	211±2mm(8.31inch)
	Total Height	215±2mm(8.46inch)
Approx. Weight		28.5kg(62.8lbs)±3%



Outer dimensions (mm)

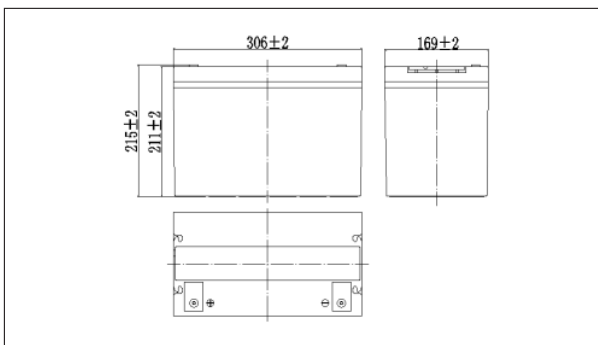

Terminal Type (mm)

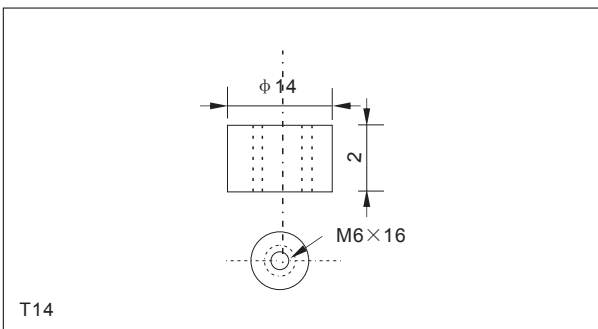

Characteristics

Capacity (25°C)	10HR(10.8V)	90Ah
	3HR(10.8V)	69Ah
	1HR(10.5V)	52Ah
Terminal type		T14
Internal resistance (Fully charged, 25°C)		Approx. 5mΩ
Capacity affected by temperature (10HR)	40°C	102%
	25°C	100%
	0°C	85%
	-15°C	65%
Self-discharge (25°C)	3 months	Remaining Capacity:91%
	6 months	Remaining Capacity:82%
	12 months	Remaining Capacity:65%
Nominal operating temperature		25°C ±3°C(77°F ±5°F)
Operating temperature range	Discharge	-15°C~50°C(5°F~122°F)
	Charge	-10°C~50°C(14°F~122°F)
	Storage	-20°C~50°C(-4°F~122°F)
Float charging voltage(25°C)		13.50 to 13.80V Temperature compensation: -18mV/°C
Cyclic charging voltage(25°C)		14.50 to 15.00V Temperature compensation: -30mV/°C
Maximum charging current		27A
Maximum discharge current		800A(5 sec.)
Designed floating life(20°C)		10years

Construction

Component	Positive plate	Negative plate	Container	Cover	Separator	Electrolyte	Safety valve	Terminal
Raw material	Lead dioxide	Lead	ABS	ABS	AGM	Sulfuric acid	Rubber	Copper

Constant Current Discharge Characteristics Unit:A(25°C,77°F)

F.V/Time	10min	15min	30min	60min	2h	3h	4h	5h	8h	10h	20h
9.60V	207	160	95.5	58.7	34.7	25.0	20.0	17.1	11.7	9.67	5.13
9.90V	201	156	93.6	57.8	34.5	24.9	19.8	17.0	11.7	9.65	5.12
10.2V	193	150	90.7	56.4	34.2	24.7	19.7	16.8	11.6	9.62	5.10
10.5V	184	145	88.5	54.6	33.7	24.5	19.6	16.7	11.5	9.57	5.07
10.8V	174	137	85.3	52.8	32.8	23.8	19.0	16.2	11.2	9.50	5.04

Constant Power Discharge Characteristics Unit:W(25°C,77°F)

F.V/Time	10min	15min	30min	60min	2h	3h	4h	5h	8h	10h	20h
9.60V	2237	1752	1071	669	402	294	235	202	139	115	61.5
9.90V	2170	1710	1050	659	400	292	233	200	138	115	61.4
10.2V	2080	1647	1018	643	396	290	232	199	138	115	61.2
10.5V	1991	1591	993	622	390	288	230	198	137	114	60.8
10.8V	1879	1507	957	602	380	280	223	192	132	113	60.4

Note: The above characteristics data can be obtained within three charge or discharge cycles.

NPD12-90Ah 12V90Ah

● **Discharge characteristics(25°C)**

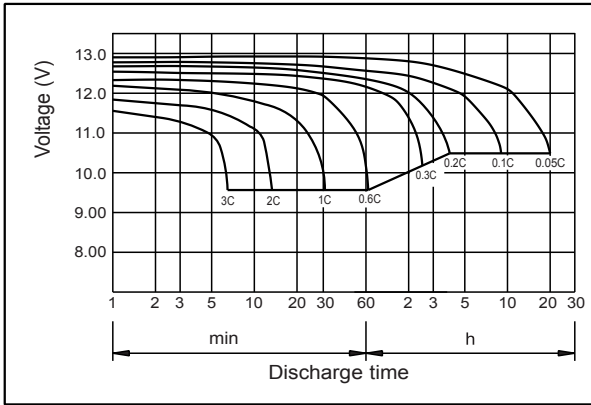

● **Charging characteristics (25°C)**

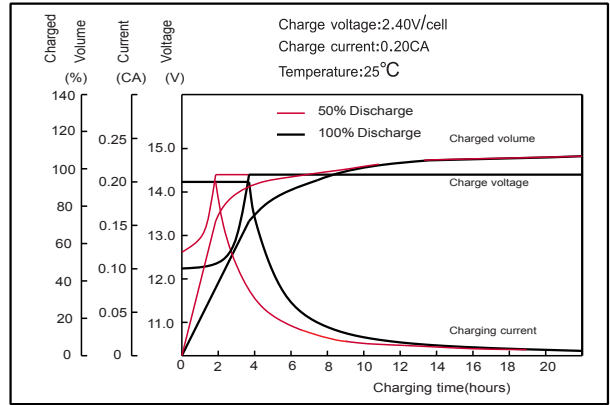

● **Temperature effects on Capacity**

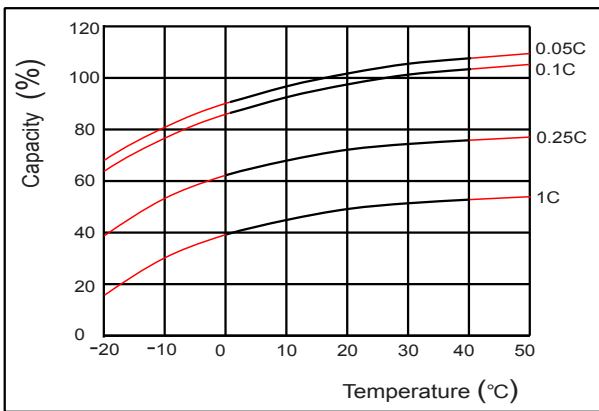

● **Self-discharge characteristics**

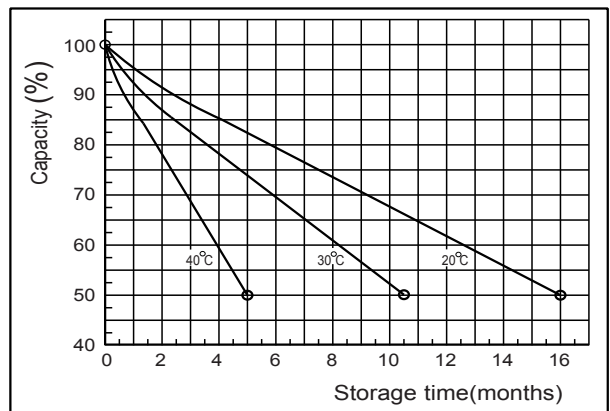

● **Floating life on Temperature**

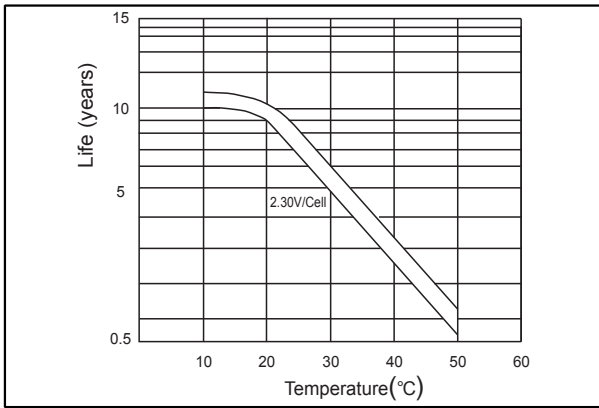

● **Cycle life on D.O.D (25°C)**

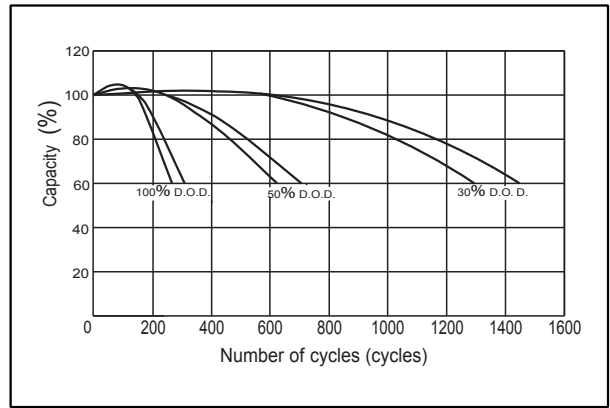

● **The relationship for OCV and Capacity (25°C)**

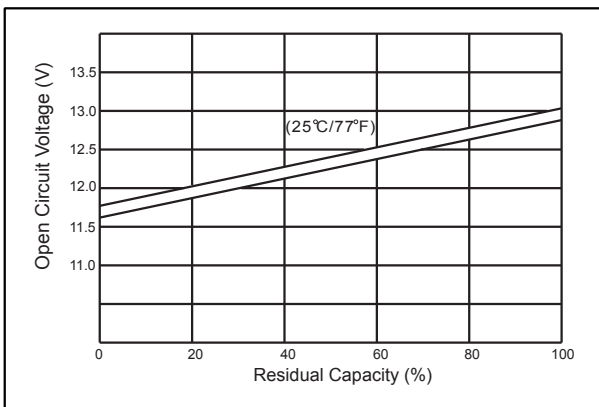

● **The relationship for Charging voltage and Temperature**

