

NPD6-180Ah 6V180Ah

Specifications

Nominal Voltage		6V
Rated capacity (10 hour rate)		180Ah
Dimensions	Length	306±2mm(12.05inch)
	Width	169±2mm(6.65inch)
	Height	220±2mm(8.66inch)
	Total Height	225±2mm(8.86inch)
Approx. Weight		29.5kg(65lbs)±3%



Outer dimensions (mm)

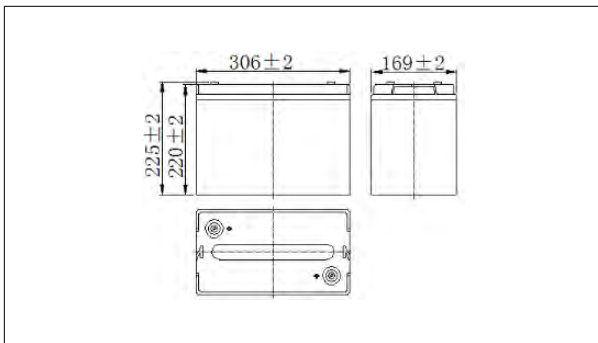

Terminal Type (mm)

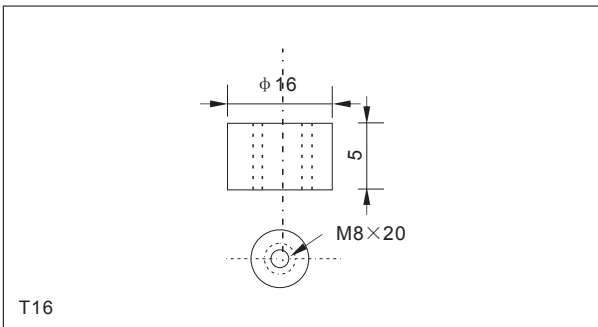

Characteristics

Capacity (25°C)	10HR(5.40V)	180Ah
	3HR(5.40V)	135Ah
	1HR(5.25V)	102Ah
Terminal type		T16
Internal resistance (Fully charged, 25°C)		Approx. 2m Ω
Capacity affected by temperature (10HR)	40°C	102%
	25°C	100%
	0°C	85%
	-15°C	65%
Self-discharge (25°C)	3 months	Remaining Capacity:91%
	6 months	Remaining Capacity:82%
	12 months	Remaining Capacity:65%
Nominal operating temperature		25°C ±3°C(77°F ±5°F)
Operating temperature range	Discharge	-15°C~50°C(5°F~122°F)
	Charge	-10°C~50°C(14°F~122°F)
	Storage	-20°C~50°C(-4°F~122°F)
Float charging voltage(25°C)		6.75 to 6.90V Temperature compensation: -9mV/°C
Cyclic charging voltage(25°C)		7.25 to 7.50V Temperature compensation: -15mV/°C
Maximum charging current		54A
Maximum discharge current		1250A(5 sec.)
Designed floating life(20°C)		10years

Construction

Component	Positive plate	Negative plate	Container	Cover	Separator	Electrolyte	Safety valve	Terminal
Raw material	Lead dioxide	Lead	ABS	ABS	AGM	Sulfuric acid	Rubber	Copper

Constant Current Discharge Characteristics Unit:A(25°C,77°F)

F.V/Time	10min	15min	30min	60min	2h	3h	4h	5h	8h	10h	20h
4.80V	403	311	186	114	67.6	48.7	38.9	33.2	22.8	18.8	9.98
4.95V	391	303	182	113	67.2	48.4	38.6	33.0	22.7	18.8	9.96
5.10V	375	292	177	110	66.6	48.1	38.4	32.8	22.5	18.7	9.93
5.25V	359	282	172	106	65.6	47.7	38.1	32.6	22.4	18.6	9.87
5.40V	339	267	166	103	63.9	46.3	37.0	31.6	21.7	18.5	9.81

Constant Power Discharge Characteristics Unit:W(25°C,77°F)

F.V/Time	10min	15min	30min	60min	2h	3h	4h	5h	8h	10h	20h
4.80V	2178	1706	1043	652	391	286	229	196	136	112	59.9
4.95V	2112	1665	1022	642	389	285	227	195	135	112	59.8
5.10V	2025	1604	991	626	386	283	226	194	134	112	59.6
5.25V	1938	1549	967	606	380	281	224	192	133	111	59.2
5.40V	1829	1467	931	587	370	272	217	187	129	110	58.8

Note: The above characteristics data can be obtained within three charge or discharge cycles.

NPD6-180Ah 6V180Ah

Discharge characteristics(25°C)

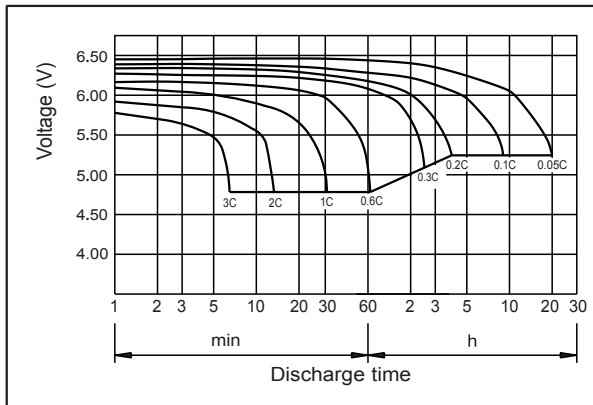

Charging characteristics(25°C)

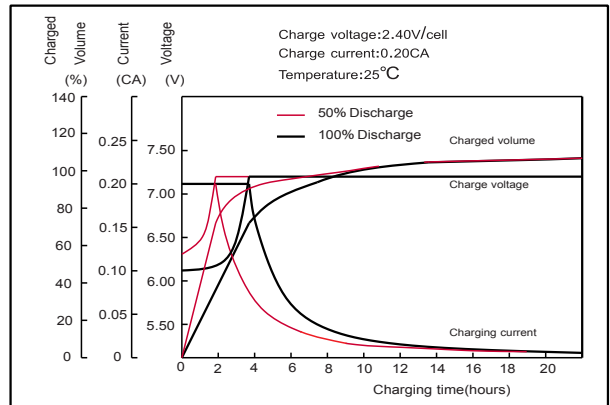

Effect of temperature on capacity

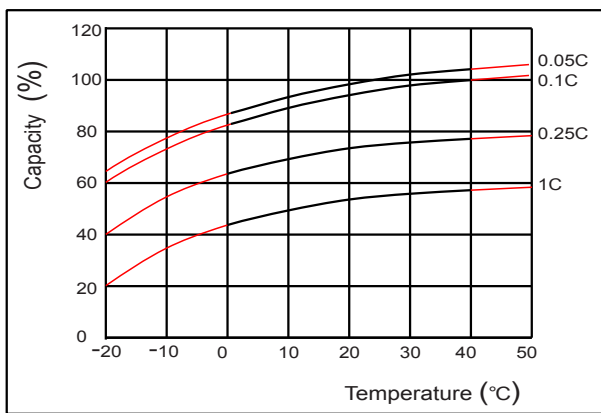

Self-discharge characteristics

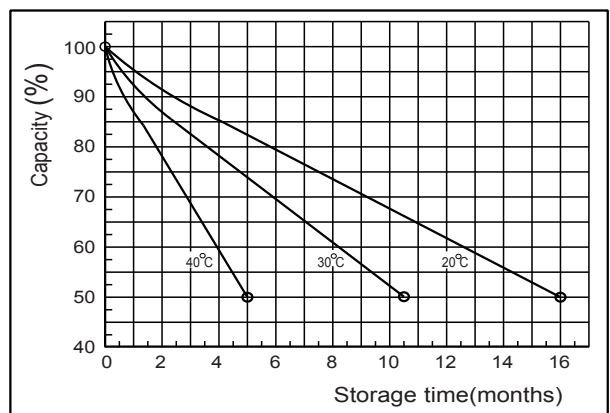

Floating life on temperature

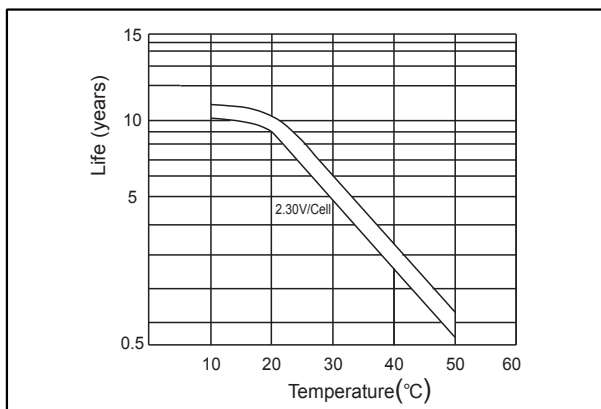

Cycle life on D.O.D (25°C)

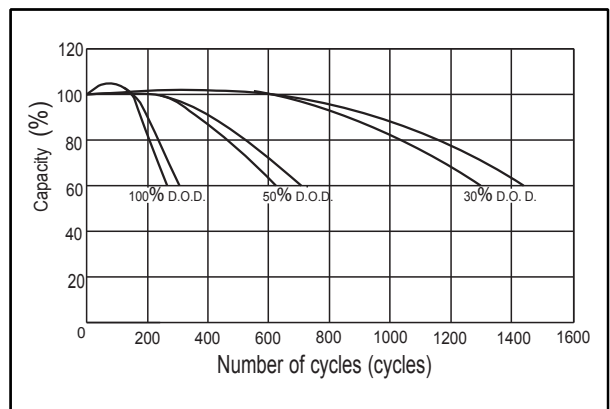

The relationship for OCV and Capacity (25°C)

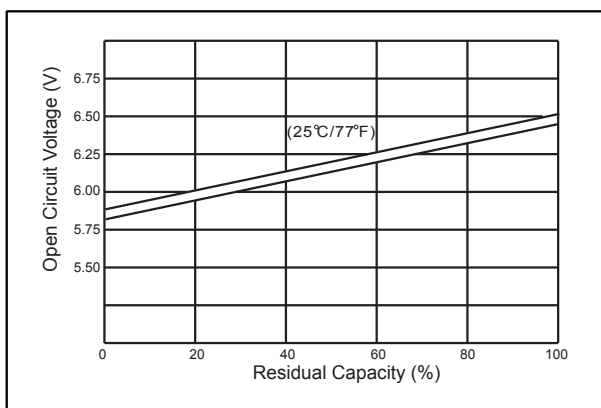

The relationship for Charging voltage and Temperature

