

## NP12-26Ah 12V26Ah

### Specifications

Nominal Voltage		12V
Rated capacity (20 hour rate)		26Ah
Dimensions	Length	166±2mm(6.54inch)
	Width	175±2mm(6.89inch)
	Height	125±2mm(4.92inch)
	Total Height	125±2mm(4.92inch)
Approx. Weight		7.9kg(17.4lbs)±4%



### Outer dimensions (mm)

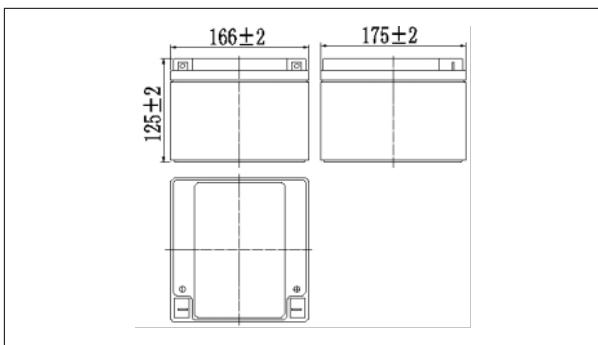

### Terminal Type (mm)

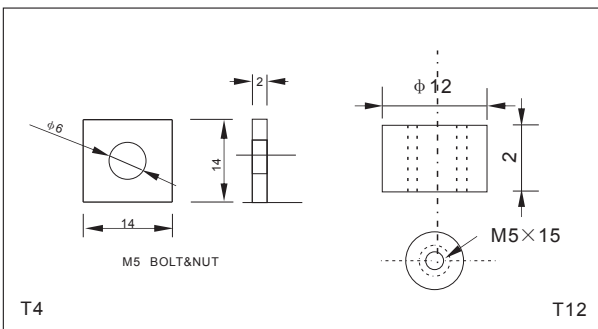

### Characteristics

Capacity (25°C)	20HR(10.5V)	26Ah
	10HR(10.5V)	24Ah
	1HR(9.60V)	16Ah
Terminal type		T4/T12
Internal resistance (Fully charged, 25°C)		Approx. 12m Ω
Capacity affected by temperature (20HR)	40°C	102%
	25°C	100%
	0°C	85%
	-15°C	65%
Self-discharge (25°C)	3 months	Remaining Capacity:91%
	6 months	Remaining Capacity:82%
	12 months	Remaining Capacity:65%
Nominal operating temperature		25°C ±3°C(77°F ±5°F)
Operating temperature range	Discharge	-15°C~50°C(5°F~122°F)
	Charge	-10°C~50°C(14°F~122°F)
	Storage	-20°C~50°C(-4°F~122°F)
Float charging voltage(25°C)		13.50 to 13.80V Temperature compensation: -18mV/°C
Cyclic charging voltage(25°C)		14.50 to 15.00V Temperature compensation: -30mV/°C
Maximum charging current		7.8A
Maximum discharge current		360A(5 sec.)
Designed floating life(20°C)		5 years

### Construction

Component	Positive plate	Negative plate	Container	Cover	Separator	Electrolyte	Safety valve	Terminal
Raw material	Lead dioxide	Lead	ABS	ABS	AGM	Sulfuric acid	Rubber	Copper

### Constant Current Discharge Characteristics Unit:A(25°C,77°F)

F.V/Time	5min	10min	15min	30min	60min	2h	3h	4h	5h	10h	20h
9.60V	97.3	61.7	48.2	27.1	16.7	9.32	6.44	5.33	4.53	2.46	1.32
9.90V	94.4	59.8	47.0	26.6	16.4	9.26	6.41	5.30	4.51	2.45	1.31
10.2V	90.5	57.3	45.3	25.8	16.0	9.18	6.36	5.26	4.48	2.44	1.31
10.5V	86.6	54.9	43.7	25.2	15.7	9.04	6.32	5.23	4.45	2.43	1.30
10.8V	81.8	51.8	41.4	24.2	15.2	8.81	6.13	5.07	4.31	2.38	1.27

### Constant Power Discharge Characteristics Unit:W(25°C,77°F)

F.V/Time	5min	10min	15min	30min	60min	2h	3h	4h	5h	10h	20h
9.60V	1086	696	549	311	193	109	76.6	63.5	54.1	29.5	15.8
9.90V	1054	675	536	305	190	108	76.1	63.1	53.8	29.4	15.8
10.2V	1010	647	516	295	186	107	75.6	62.7	53.5	29.3	15.7
10.5V	967	619	498	288	182	106	75.1	62.2	53.1	29.1	15.6
10.8V	912	584	472	278	176	103	72.8	60.4	51.5	28.5	15.3

Note: The above characteristics data can be obtained within three charge or discharge cycles.

# NP12-26Ah 12V26Ah

● **Discharge characteristics(25°C)**

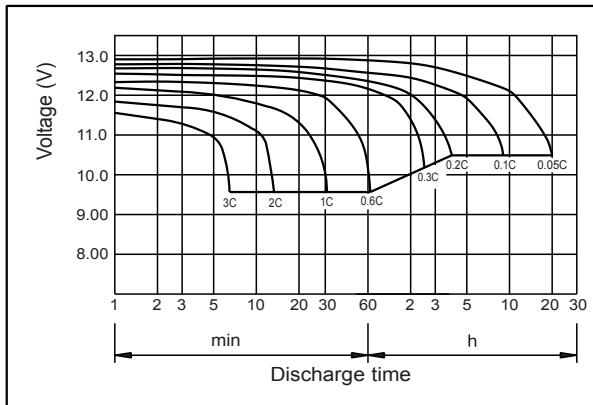

● **Charging characteristics (25°C)**

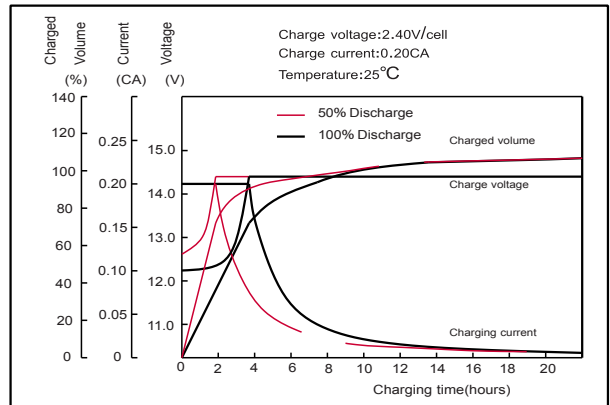

● **Effect of temperature on capacity**

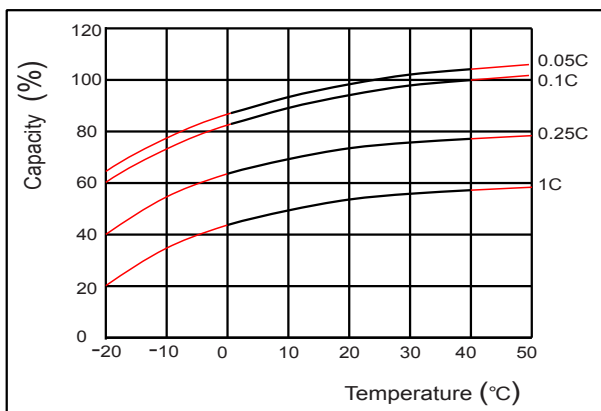

● **Self-discharge characteristics**

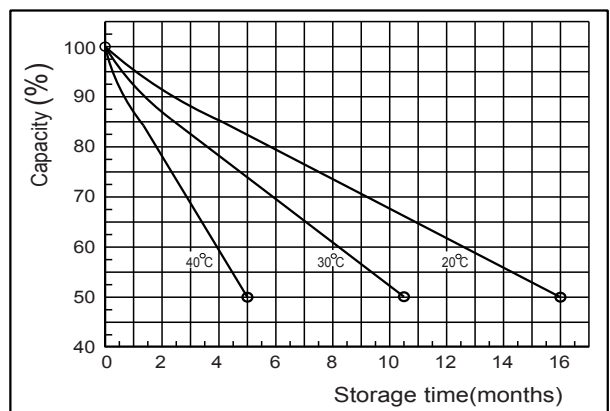

● **Floating life on temperature**

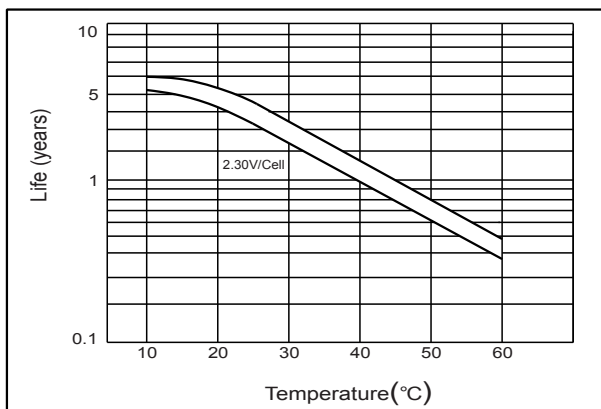

● **Cycle life on D.O.D.(25°C)**

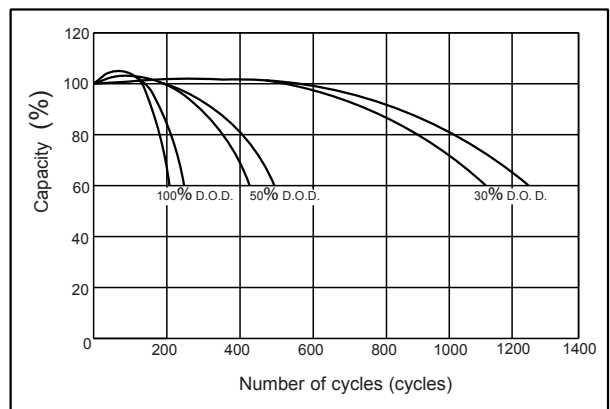

● **The relationship for OCV and Capacity (25°C)**

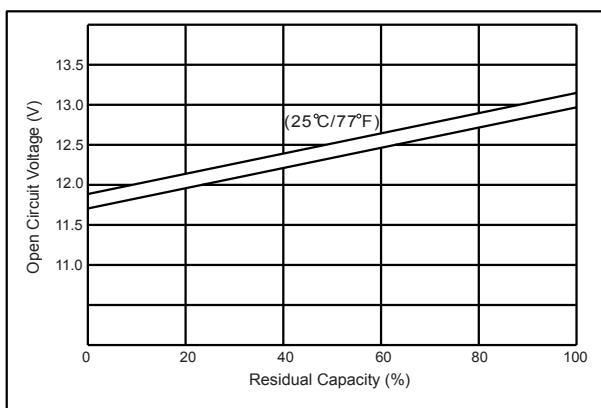

● **The relationship for Charging voltage and Temperature**

