

NP12-4Ah 12V4Ah

● Specifications

Nominal Voltage		12V
Rated capacity (20 hour rate)		4Ah
Dimensions	Length	90±1mm(3.54inch)
	Width	70±1mm(2.76inch)
	Height	101±1mm(3.98inch)
	Total Height	107±1mm(4.21inch)
Approx. Weight		1.35kg(2.98lbs)±4%



● Outer dimensions (mm)

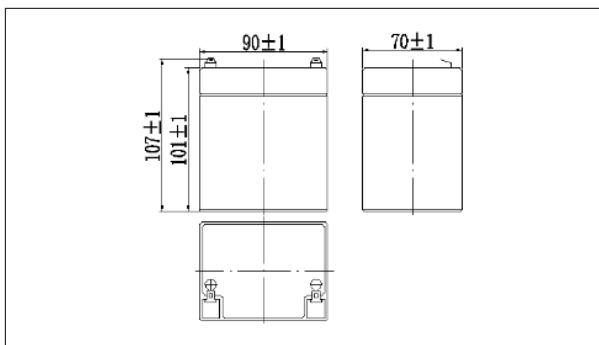

● Terminal Type (mm)

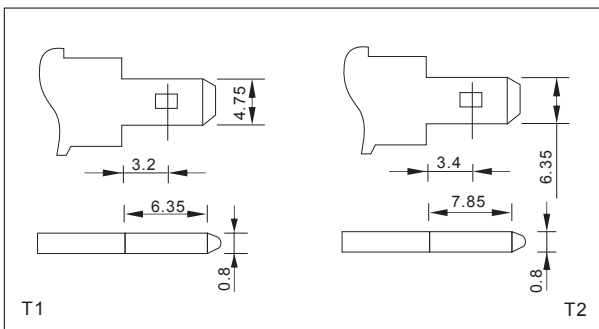

● Characteristics

Capacity (25°C)	20HR(10.5V)	4Ah
	10HR(10.5V)	3.7Ah
	1HR(9.60V)	2.4Ah
Terminal type		T1/T2
Internal resistance (Fully charged, 25°C)		Approx. 55m Ω
Capacity affected by temperature (20HR)	40°C	102%
	25°C	100%
	0°C	85%
	-15°C	65%
Self-discharge (25°C)	3 months	Remaining Capacity:91%
	6 months	Remaining Capacity:82%
	12 months	Remaining Capacity:65%
Nominal operating temperature		25°C ±3°C(77°F ±5°F)
Operating temperature range	Discharge	-15°C~50°C(5°F~122°F)
	Charge	-10°C~50°C(14°F~122°F)
	Storage	-20°C~50°C(-4°F~122°F)
Float charging voltage(25°C)		13.50 to 13.80V Temperature compensation: -18mV/°C
Cyclic charging voltage(25°C)		14.50 to 15.00V Temperature compensation: -30mV/°C
Maximum charging current		1.2A
Maximum discharge current		60A(5 sec.)
Designed floating life(20°C)		5 years

● Construction

Component	Positive plate	Negative plate	Container	Cover	Separator	Electrolyte	Safety valve	Terminal
Raw material	Lead dioxide	Lead	ABS	ABS	AGM	Sulfuric acid	Rubber	Copper

● Constant Current Discharge Characteristics Unit:A(25°C,77°F)

F.V/Time	5min	10min	15min	30min	60min	2h	3h	4h	5h	10h	20h
9.60V	15.3	9.68	7.56	4.26	2.62	1.43	0.99	0.82	0.70	0.38	0.20
9.90V	14.8	9.39	7.38	4.17	2.58	1.42	0.99	0.82	0.69	0.38	0.20
10.2V	14.2	9.00	7.11	4.05	2.52	1.41	0.98	0.81	0.69	0.38	0.20
10.5V	13.6	8.62	6.86	3.95	2.47	1.39	0.97	0.80	0.68	0.37	0.20
10.8V	12.8	8.13	6.50	3.80	2.39	1.36	0.94	0.78	0.66	0.37	0.20

● Constant Power Discharge Characteristics Unit:W(25°C,77°F)

F.V/Time	5min	10min	15min	30min	60min	2h	3h	4h	5h	10h	20h
9.60V	171	109	86.2	48.8	30.3	16.8	11.8	9.77	8.33	4.55	2.44
9.90V	165	106	84.1	47.8	29.9	16.7	11.7	9.71	8.28	4.53	2.43
10.2V	159	102	81.0	46.4	29.1	16.5	11.6	9.64	8.22	4.51	2.41
10.5V	152	97.2	78.3	45.3	28.5	16.3	11.5	9.58	8.17	4.48	2.40
10.8V	143	91.7	74.1	43.6	27.7	15.9	11.2	9.29	7.92	4.39	2.35

Note: The above characteristics data can be obtained within three charge or discharge cycles.

NP12-4Ah 12V4Ah

Discharge characteristics(25°C)

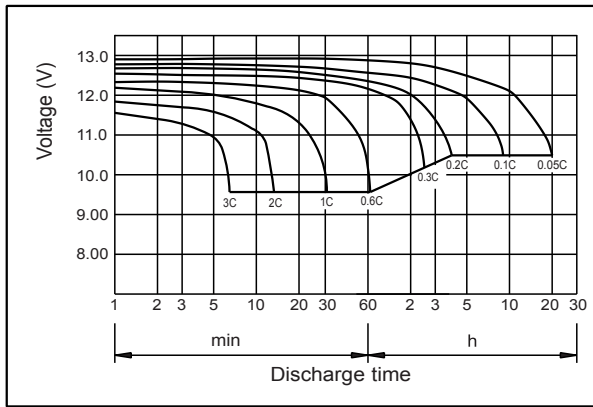

Charging characteristics (25°C)

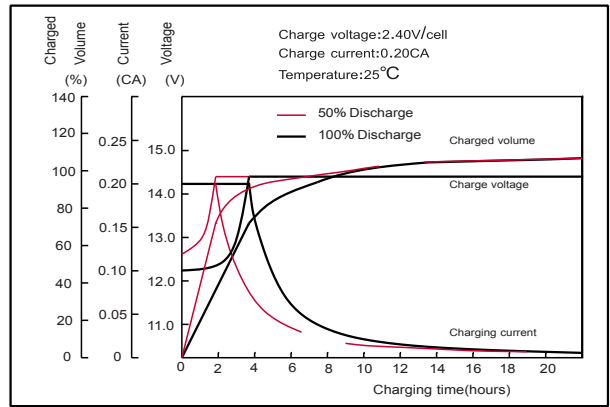

Effect of temperature on capacity

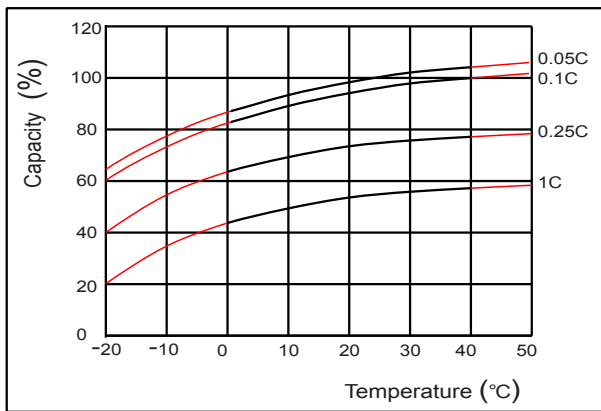

Self-discharge characteristic

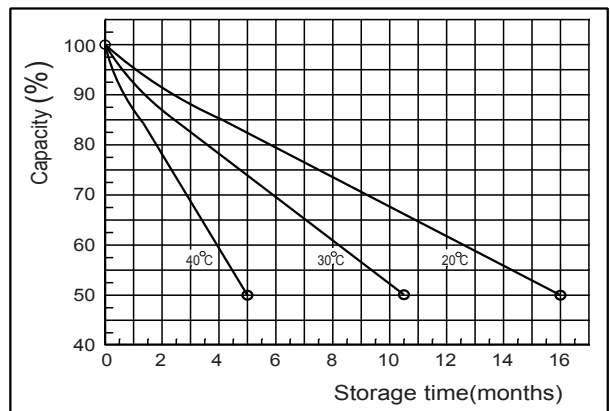

Floating life on temperature

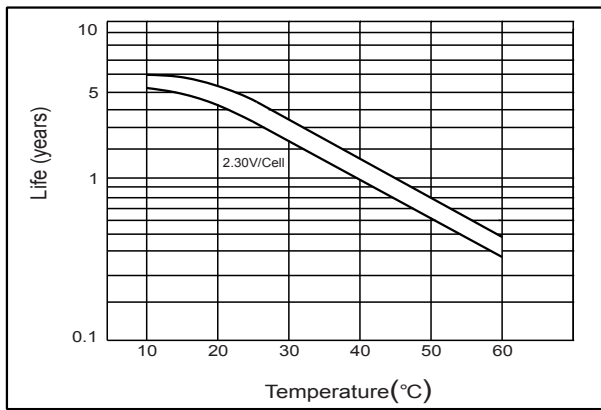

Cycle life on D.O.D(25°C)

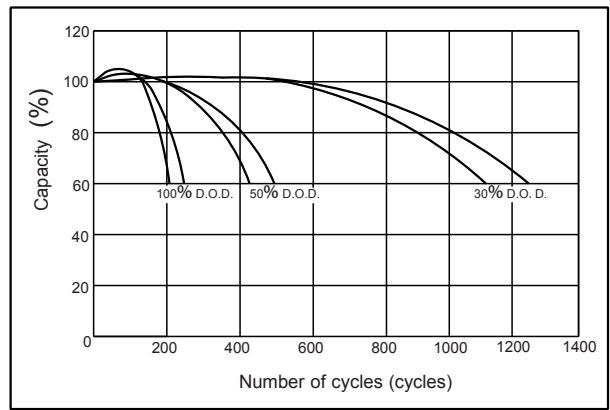

The relationship for OCV and Capacity (25°C)

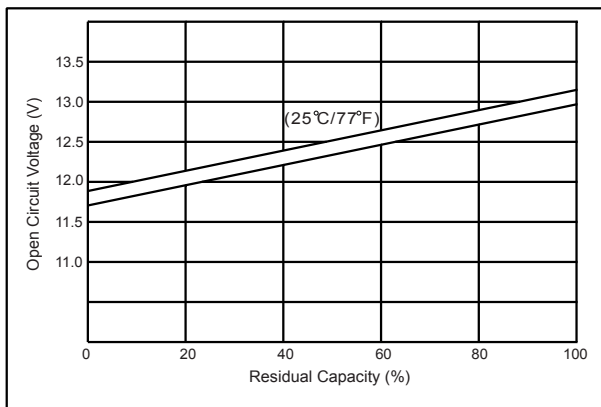

The relationship for Charging voltage and Temperature

