

NP12-2.3Ah 12V2.3Ah

Specifications

Nominal Voltage		12V
Rated capacity (20 hour rate)		2.3Ah
Dimensions	Length	178±2mm(7.01inch)
	Width	34±1mm(1.34inch)
	Height	60±1mm(2.36inch)
	Total Height	66±1mm(2.60inch)
Approx. Weight		0.9kg(1.98lbs)±5%



Outer dimensions (mm)

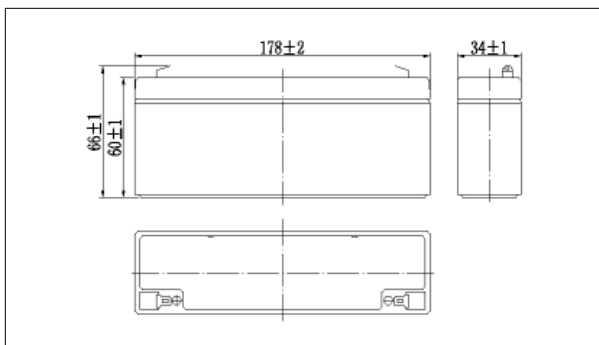

Terminal Type (mm)

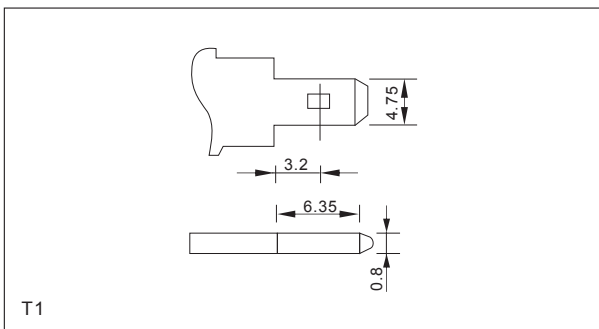

Characteristics

Capacity (25°C)	20HR(10.5V)	2.3Ah
	10HR(10.5V)	2.1Ah
	1HR(9.60V)	1.4Ah
Terminal type		T1
Internal resistance (Fully charged, 25°C)		Approx. 60m Ω
Capacity affected by temperature (20HR)	40°C	102%
	25°C	100%
	0°C	85%
	-15°C	65%
Self-discharge (25°C)	3 months	Remaining Capacity:91%
	6 months	Remaining Capacity:82%
	12 months	Remaining Capacity:65%
Nominal operating temperature		25°C ±3°C(77°F ±5°F)
Operating temperature range	Discharge	-15°C~50°C(5°F~122°F)
	Charge	-10°C~50°C(14°F~122°F)
	Storage	-20°C~50°C(-4°F~122°F)
Float charging voltage(25°C)		13.50 to 13.80V Temperature compensation: -18mV/°C
Cyclic charging voltage(25°C)		14.50 to 15.00V Temperature compensation: -30mV/°C
Maximum charging current		0.69A
Maximum discharge current		34.5A(5 sec.)
Designed floating life(20°C)		5 years

Construction

Component	Positive plate	Negative plate	Container	Cover	Separator	Electrolyte	Safety valve	Terminal
Raw material	Lead dioxide	Lead	ABS	ABS	AGM	Sulfuric acid	Rubber	Copper

Constant Current Discharge Characteristics Unit:A(25°C,77°F)

F.V/Time	5min	10min	15min	30min	60min	2h	3h	4h	5h	10h	20h
9.60V	8.79	5.57	4.35	2.45	1.51	0.82	0.57	0.47	0.40	0.22	0.117
9.90V	8.52	5.40	4.24	2.40	1.48	0.82	0.57	0.47	0.40	0.22	0.116
10.2V	8.17	5.18	4.09	2.33	1.45	0.81	0.56	0.47	0.40	0.22	0.116
10.5V	7.82	4.95	3.95	2.27	1.42	0.80	0.56	0.46	0.39	0.21	0.115
10.8V	7.38	4.68	3.74	2.19	1.37	0.78	0.54	0.45	0.38	0.21	0.113

Constant Power Discharge Characteristics Unit:W(25°C,77°F)

F.V/Time	5min	10min	15min	30min	60min	2h	3h	4h	5h	10h	20h
9.60V	98.1	62.8	49.6	28.1	17.4	9.64	6.77	5.62	4.79	2.61	1.40
9.90V	95.1	60.9	48.4	27.5	17.2	9.58	6.73	5.58	4.76	2.60	1.40
10.2V	91.2	58.4	46.6	26.7	16.7	9.50	6.69	5.54	4.73	2.59	1.39
10.5V	87.3	55.9	45.0	26.0	16.4	9.36	6.64	5.51	4.70	2.58	1.38
10.8V	82.4	52.7	42.6	25.1	15.9	9.12	6.44	5.34	4.56	2.52	1.35

Note: The above characteristics data can be obtained within three charge or discharge cycles.

NP12-2.3Ah 12V2.3Ah

Discharge characteristics(25°C)

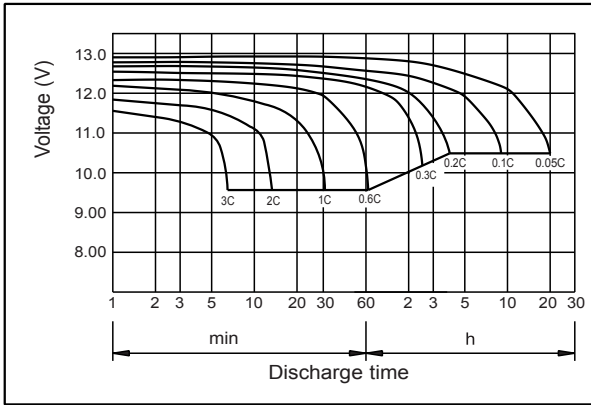

Charging characteristics (25°C)

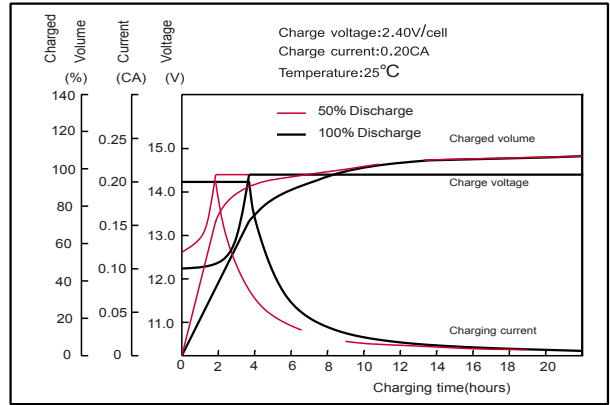

Effect of temperature on capacity

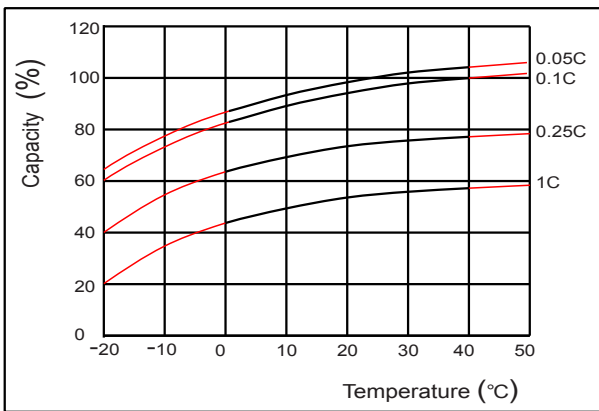

Self-discharge characteristics

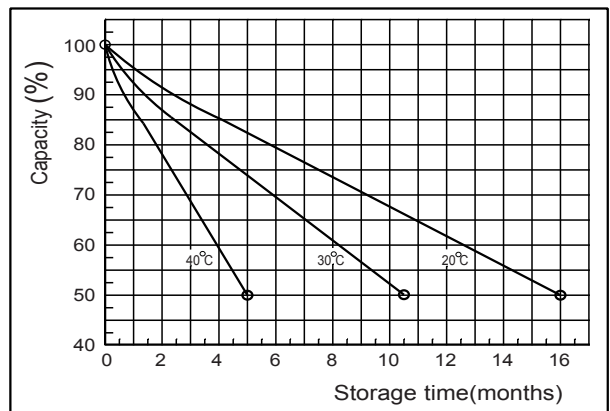

Floating life on temperature

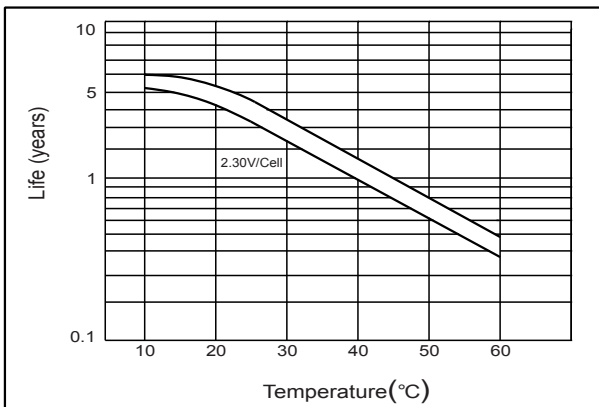

Cycle life on D.O.D(25°C)

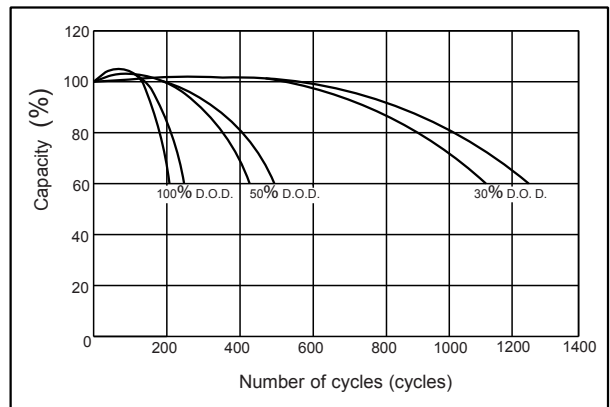

The relationship for OCV and Capacity (25°C)

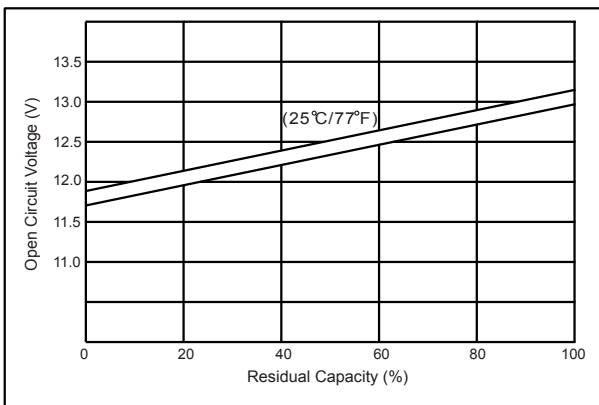

The relationship for Charging voltage and Temperature

