

## NP12-1.9Ah 12V1.9Ah

### Specifications

Nominal Voltage		12V
Rated capacity (20 hour rate)		1.9Ah
Dimensions	Length	178±2mm(7.01inch)
	Width	34±1mm(1.69inch)
	Height	60±1mm(2.36inch)
	Total Height	66±1mm(2.60inch)
Approx. Weight		0.78kg(1.72lbs)±5%



### Outer dimensions (mm)

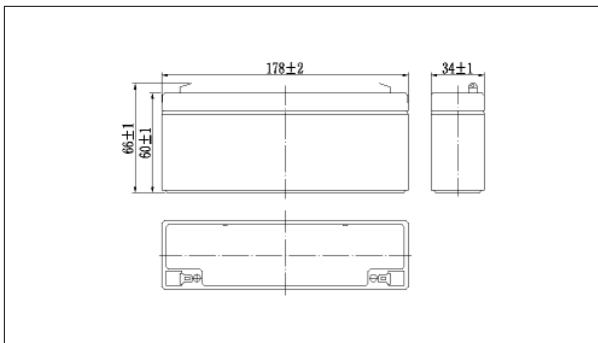

### Terminal Type (mm)

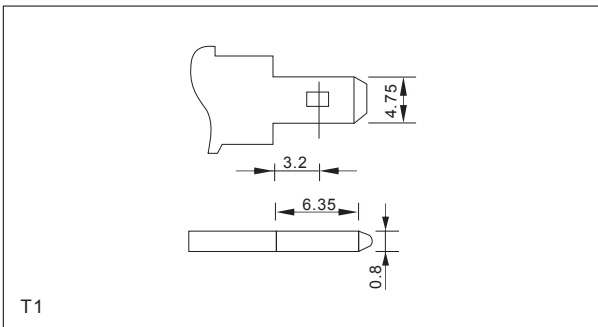

### Characteristics

Capacity (25°C)	20HR(10.5V)	1.9Ah
	10HR(10.5V)	1.8Ah
	1HR(9.60V)	1.2Ah
Terminal type		T1
Internal resistance (Fully charged,25°C)		Approx.65m Ω
Capacity affected by temperature (20HR)	40°C	102%
	25°C	100%
	0°C	85%
	-15°C	65%
Self-discharge (25°C)	3 months	Remaining Capacity:91%
	6 months	Remaining Capacity:82%
	12 months	Remaining Capacity:65%
Nominal operating temperature		25°C ±3°C(77°F ±5°F)
Operating temperature range	Discharge	-15°C~50°C(5°F~122°F)
	Charge	-10°C~50°C(14°F~122°F)
	Storage	-20°C~50°C(-4°F~122°F)
Float charging voltage(25°C)		13.50 to 13.80V Temperature compensation: -18mV/°C
Cyclic charging voltage(25°C)		14.50 to 15.00V Temperature compensation: -30mV/°C
Maximum charging current		0.57A
Maximum discharge current		28.5A(5 sec.)
Designed floating life(20°C)		5 years

### Construction

Component	Positive plate	Negative plate	Container	Cover	Separator	Electrolyte	Safety valve	Terminal
Raw material	Lead dioxide	Lead	ABS	ABS	AGM	Sulfuric acid	Rubber	Copper

### Constant Current Discharge Characteristics Unit:A(25°C,77°F)

F.V/Time	5min	10min	15min	30min	60min	2h	3h	4h	5h	10h	20h
9.60V	7.26	4.60	3.59	2.02	1.24	0.68	0.47	0.39	0.33	0.18	0.096
9.90V	7.04	4.46	3.50	1.98	1.23	0.68	0.47	0.39	0.33	0.18	0.096
10.2V	6.75	4.28	3.38	1.92	1.19	0.67	0.46	0.38	0.33	0.18	0.096
10.5V	6.46	4.09	3.26	1.88	1.17	0.66	0.46	0.38	0.32	0.18	0.095
10.8V	6.10	3.86	3.09	1.81	1.13	0.64	0.45	0.37	0.32	0.17	0.093

### Constant Power Discharge Characteristics Unit:W(25°C,77°F)

F.V/Time	5min	10min	15min	30min	60min	2h	3h	4h	5h	10h	20h
9.60V	81.0	51.9	40.9	23.2	14.4	7.96	5.59	4.64	3.96	2.16	1.16
9.90V	78.6	50.3	40.0	22.7	14.2	7.92	5.56	4.61	3.93	2.15	1.15
10.2V	75.3	48.2	38.5	22.0	13.8	7.85	5.52	4.58	3.91	2.14	1.15
10.5V	72.1	46.2	37.2	21.5	13.6	7.73	5.48	4.55	3.88	2.13	1.14
10.8V	68.0	43.6	35.2	20.7	13.1	7.53	5.32	4.41	3.76	2.08	1.12

Note: The above characteristics data can be obtained within three charge or discharge cycles.

**NP12-1.9Ah 12V1.9Ah**

**Discharge characteristics(25°C)**

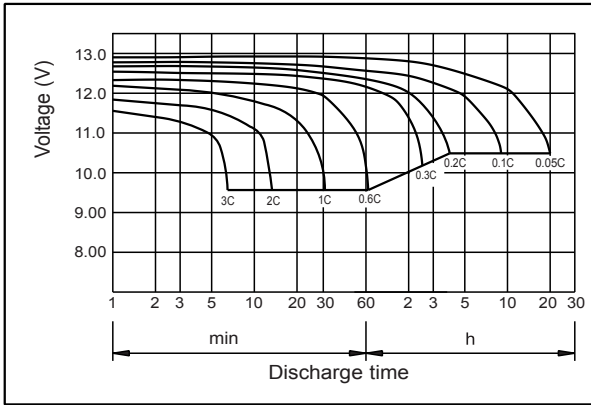

**Charging characteristics (25°C)**

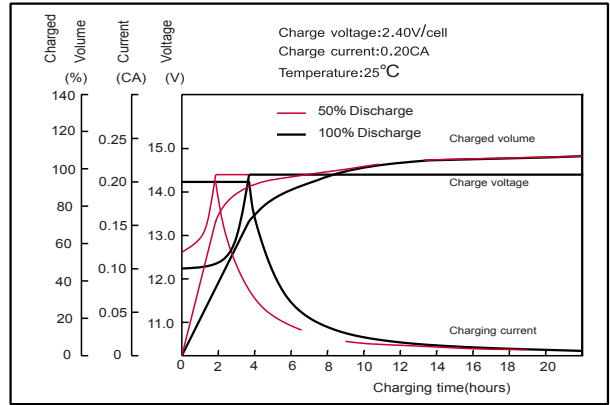

**Effect of temperature on capacity**

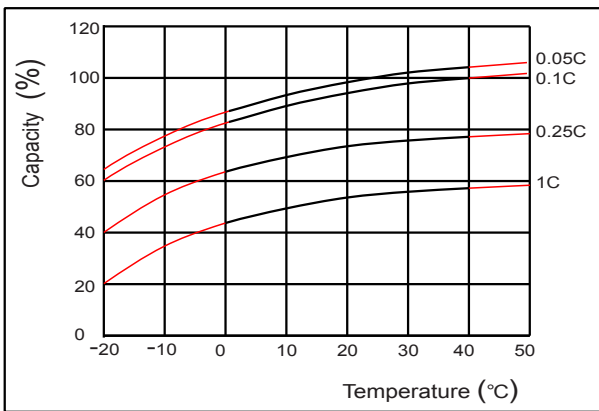

**Self-discharge characteristics**

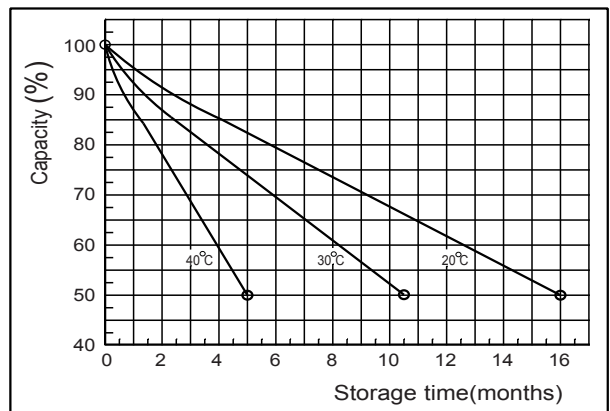

**Floating life on temperature**

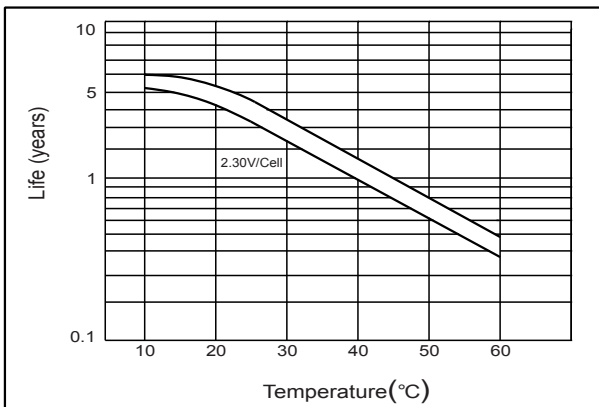

**Cycle life on D.O.D(25°C)**

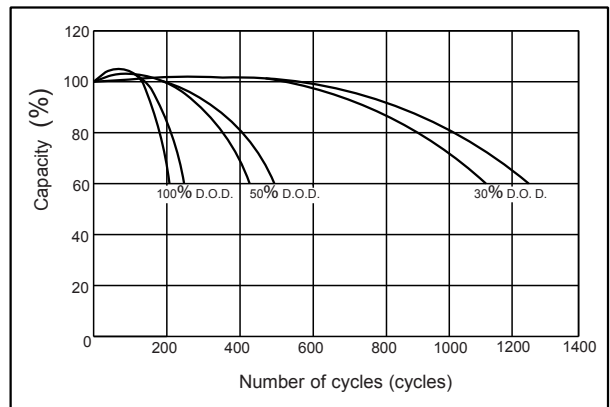

**The relationship for OCV and Capacity (25°C)**

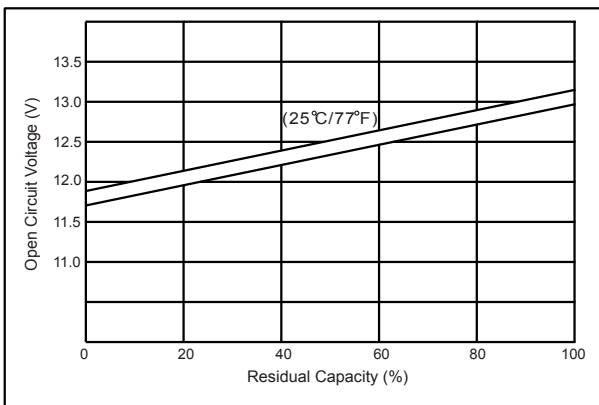

**The relationship for Charging voltage and Temperature**

