

NP6-10Ah 6V10Ah

Specifications

Nominal Voltage		6V
Rated capacity (20 hour rate)		10Ah
Dimensions	Length	151±1.5mm(5.94inch)
	Width	50±1mm(1.97inch)
	Height	94±1mm(3.70inch)
	Total Height	100±1mm(3.94inch)
Approx. Weight		1.55kg(3.42lbs)±4%



Outer dimensions (mm)

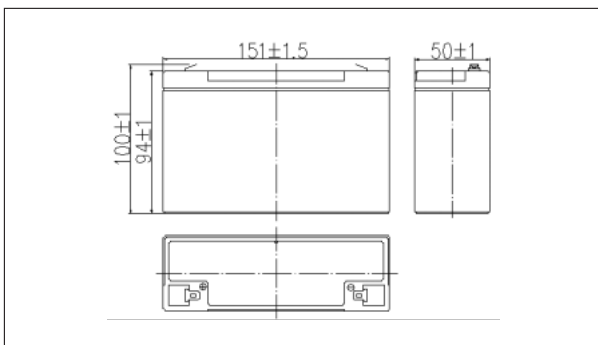

Terminal Type (mm)

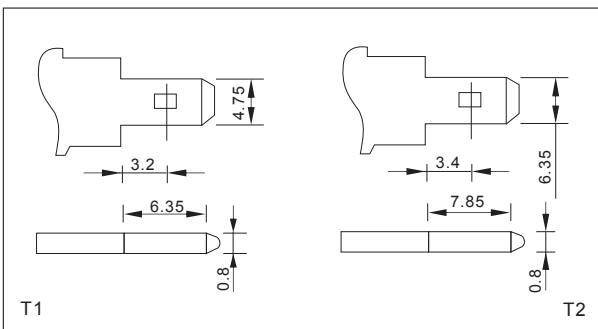

Construction

Component	Positive plate	Negative plate	Container	Cover	Separator	Electrolyte	Safety valve	Terminal
Raw material	Lead dioxide	Lead	ABS	ABS	AGM	Sulfuric acid	Rubber	Copper

Constant Current Discharge Characteristics Unit:A(25°C,77°F)

F.V/Time	5min	10min	15min	30min	60min	2h	3h	4h	5h	10h	20h
4.80V	38.2	24.2	18.9	10.7	6.55	3.58	2.48	2.05	1.74	0.95	0.51
4.95V	37.1	23.5	18.4	10.4	6.45	3.56	2.46	2.04	1.73	0.94	0.51
5.10V	35.5	22.5	17.8	10.1	6.29	3.53	2.45	2.02	1.72	0.94	0.50
5.25V	34.0	21.5	17.2	9.87	6.16	3.48	2.43	2.01	1.71	0.93	0.50
5.40V	32.1	20.3	16.3	9.51	5.97	3.39	2.36	1.95	1.66	0.91	0.49

Constant Power Discharge Characteristics Unit:W(25°C,77°F)

F.V/Time	5min	10min	15min	30min	60min	2h	3h	4h	5h	10h	20h
4.80V	213	136	108	61.0	37.9	21.0	14.7	12.2	10.4	5.68	3.05
4.95V	207	132	105	59.8	37.4	20.8	14.6	12.1	10.4	5.66	3.03
5.10V	198	127	101	58.0	36.4	20.7	14.5	12.1	10.3	5.63	3.02
5.25V	190	121	97.8	56.6	35.7	20.3	14.4	12.0	10.2	5.60	3.00
5.40V	179	115	92.6	54.5	34.6	19.8	14.0	11.6	9.90	5.49	2.94

Note: The above characteristics data can be obtained within three charge or discharge cycles.

Characteristics

Capacity (25°C)	20HR(5.25V)	10Ah
	10HR(5.25V)	9.3Ah
	1HR(4.80V)	6.0Ah
Terminal type		T1/T2
Internal resistance (Fully charged,25°C)		Approx.12m Ω
Capacity affected by temperature (20HR)	40°C	102%
	25°C	100%
	0°C	85%
	-15°C	65%
Self-discharge (25°C)	3 months	Remaining Capacity:91%
	6 months	Remaining Capacity:82%
	12 months	Remaining Capacity:65%
Nominal operating temperature		25°C ±3°C(77°F ±5°F)
Operating temperature range	Discharge	-15°C~50°C(5°F~122°F)
	Charge	-10°C~50°C(14°F~122°F)
	Storage	-20°C~50°C(-4°F~122°F)
Float charging voltage(25°C)		6.75 to 6.90V Temperature compensation: -9mV/°C
Cyclic charging voltage(25°C)		7.25 to 7.50V Temperature compensation: -15mV/°C
Maximum charging current		3A
Maximum discharge current		150A(5 sec.)
Designed floating life(20°C)		5 years

NP6-10Ah 6V10Ah

Discharge characteristics(25°C)

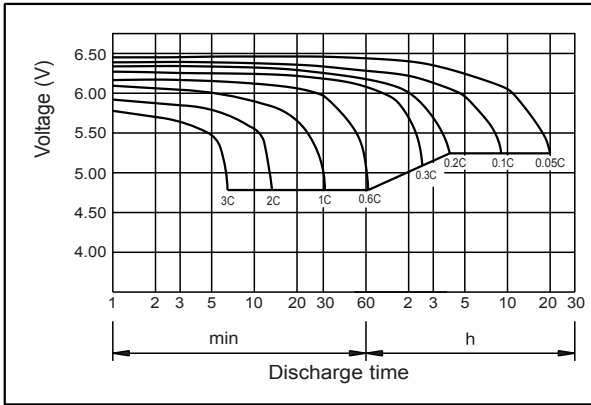

Charging characteristics (25°C)

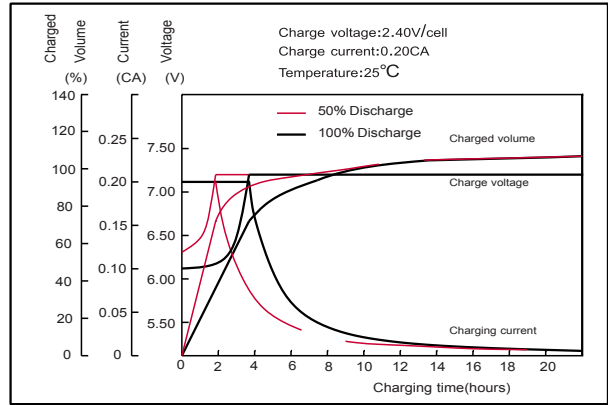

Effect of temperature on capacity



Self-discharge characteristics

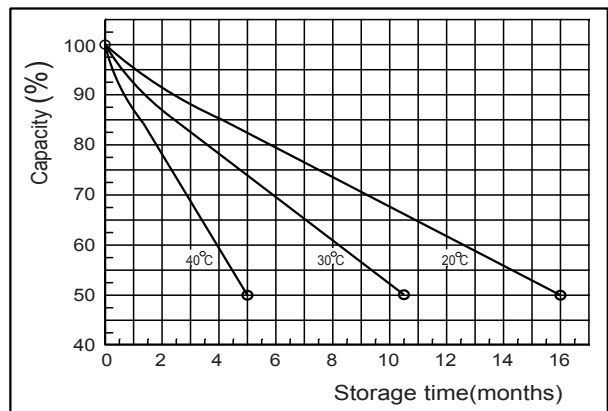

Floating life on temperature

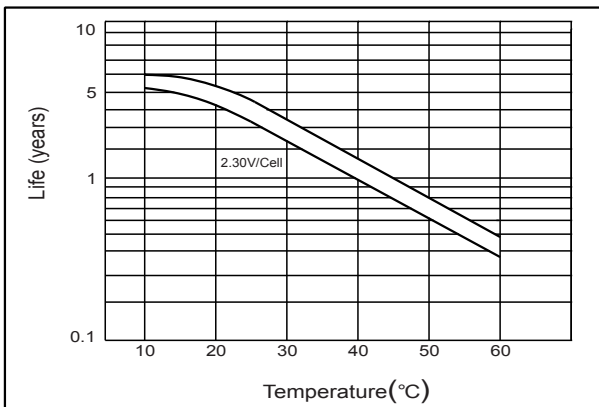

Cycle life on D.O.D(25°C)

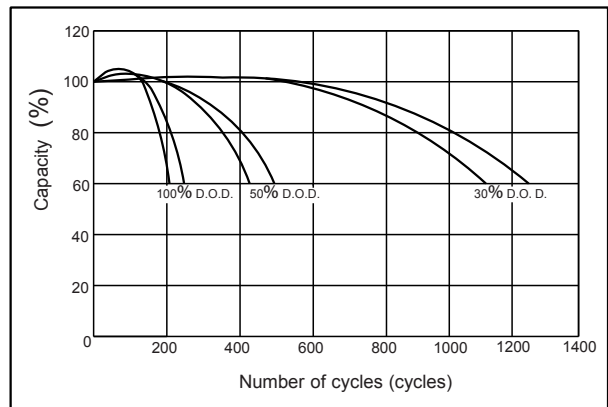

The relationship for OCV and Capacity (25°C)

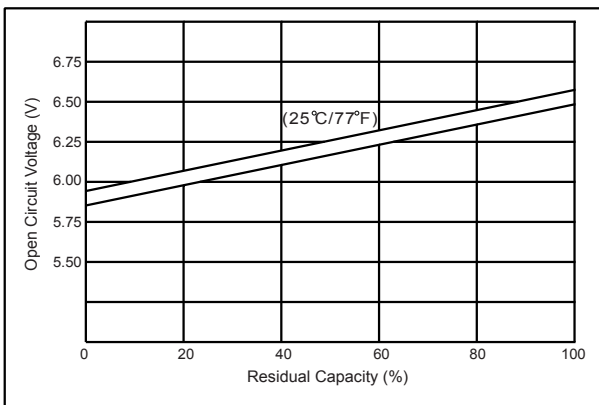

The relationship for Charging voltage and Temperature

