

## NP6-7Ah 6V7Ah



### Specifications

Nominal Voltage	6V	
Rated capacity (20 hour rate)	7Ah	
Dimensions	Length	151±1.5mm(5.94inch)
	Width	34±1mm(1.34inch)
	Height	94±1mm(3.70inch)
	Total Height	100±1mm(3.94inch)
Approx. Weight	1.1kg(2.42lbs)±5%	

### Outer dimensions (mm)

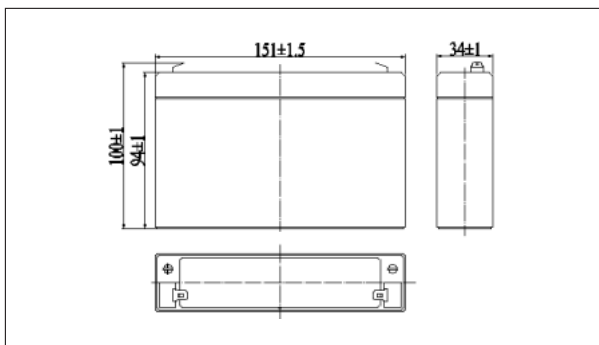

### Terminal Type (mm)

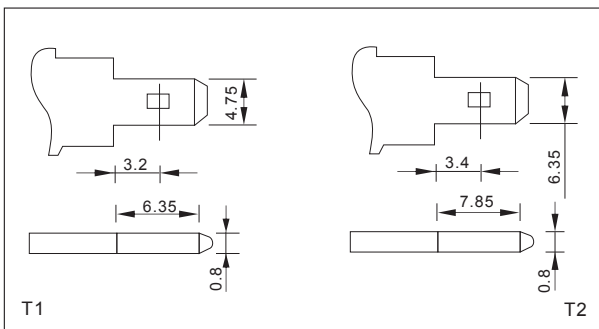

### Characteristics

Capacity (25°C)	20HR(5.25V)	7Ah
	10HR(5.25V)	6.5Ah
	1HR(4.80V)	4.2Ah
Terminal type		T1/T2
Internal resistance (Fully charged, 25°C)		Approx. 16m Ω
Capacity affected by temperature (20HR)	40°C	102%
	25°C	100%
	0°C	85%
	-15°C	65%
Self-discharge (25°C)	3 months	Remaining Capacity:91%
	6 months	Remaining Capacity:82%
	12 months	Remaining Capacity:65%
Nominal operating temperature		25°C ±3°C(77°F ±5°F)
Operating temperature range	Discharge	-15°C~50°C(5°F~122°F)
	Charge	-10°C~50°C(14°F~122°F)
	Storage	-20°C~50°C(-4°F~122°F)
Float charging voltage(25°C)		6.75 to 6.90V Temperature compensation: -9mV/°C
Cyclic charging voltage(25°C)		7.25 to 7.50V Temperature compensation: -15mV/°C
Maximum charging current		2.1A
Maximum discharge current		105A(5 sec.)
Designed floating life(20°C)		5 years

### Construction

Component	Positive plate	Negative plate	Container	Cover	Separator	Electrolyte	Safety valve	Terminal
Raw material	Lead dioxide	Lead	ABS	ABS	AGM	Sulfuric acid	Rubber	Copper

### Constant Current Discharge Characteristics Unit:A(25°C,77°F)

F.V/Time	5min	10min	15min	30min	60min	2h	3h	4h	5h	10h	20h
4.80V	26.7	16.9	13.2	7.46	4.59	2.51	1.74	1.44	1.22	0.66	0.36
4.95V	25.9	16.4	12.9	7.31	4.52	2.49	1.72	1.43	1.21	0.66	0.35
5.10V	24.9	15.8	12.4	7.08	4.40	2.47	1.71	1.42	1.21	0.66	0.35
5.25V	23.8	15.1	12.0	6.91	4.31	2.43	1.70	1.41	1.20	0.65	0.35
5.40V	22.5	14.2	11.4	6.66	4.18	2.37	1.65	1.36	1.16	0.64	0.34

### Constant Power Discharge Characteristics Unit:W(25°C,77°F)

F.V/Time	5min	10min	15min	30min	60min	2h	3h	4h	5h	10h	20h
4.80V	149	95.5	75.4	42.7	26.5	14.7	10.3	8.55	7.29	3.98	2.13
4.95V	145	92.7	73.6	41.9	26.1	14.6	10.2	8.50	7.25	3.96	2.12
5.10V	139	88.9	70.9	40.6	25.5	14.5	10.2	8.44	7.20	3.94	2.11
5.25V	133	85.0	68.5	39.6	25.0	14.2	10.1	8.38	7.15	3.92	2.10
5.40V	125	80.3	64.9	38.1	24.2	13.9	9.8	8.13	6.93	3.84	2.06

Note: The above characteristics data can be obtained within three charge or discharge cycles.

# NP6-7Ah 6V7Ah

● **Discharge characteristics(25°C)**

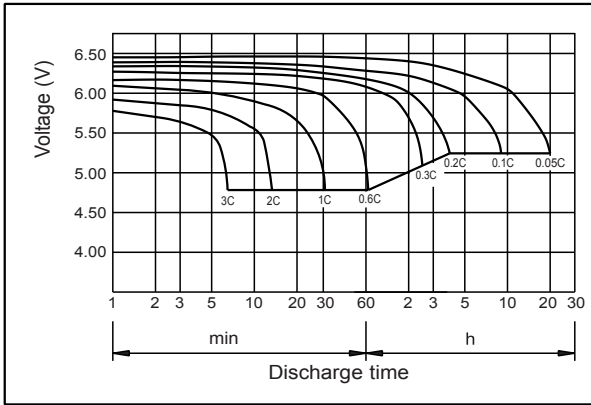

● **Charging characteristics (25°C)**

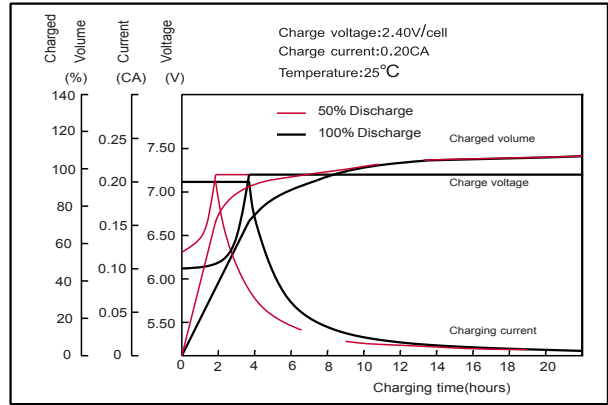

● **Effect of temperature on capacity**

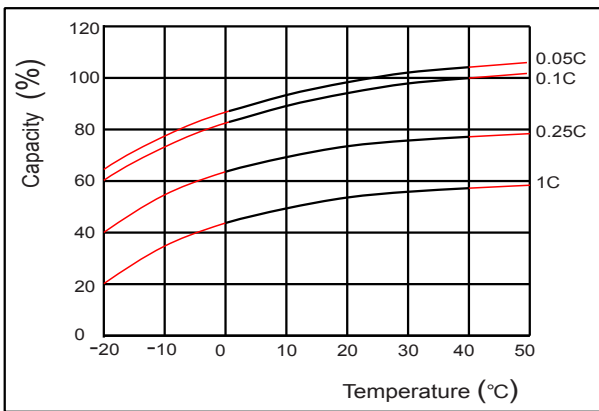

● **Self-discharge characteristics**

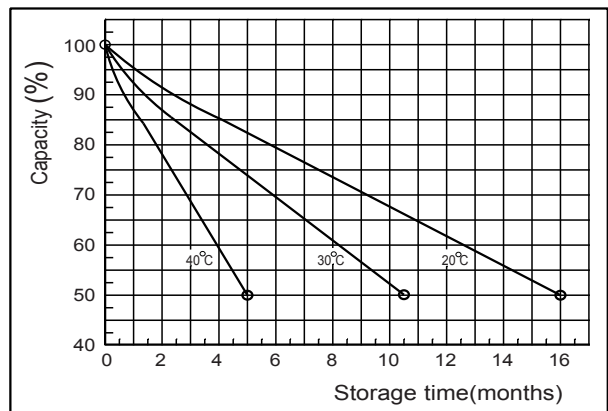

● **Floating life on temperature**

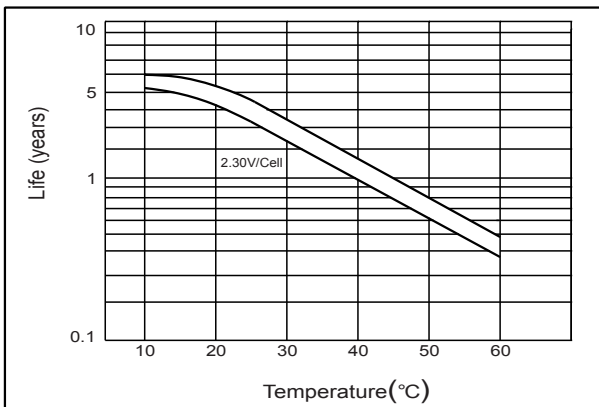

● **Cycle life on D.O.D(25°C)**

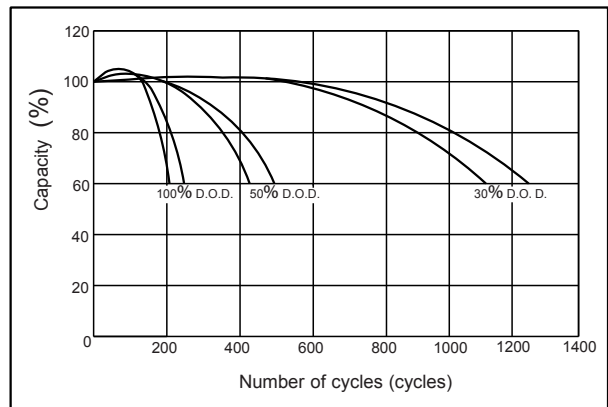

● **The relationship for OCV and Capacity (25°C)**

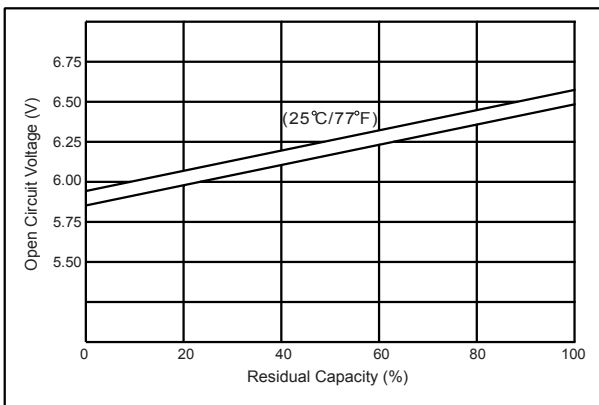

● **The relationship for Charging voltage and Temperature**

